



GRASPOINTNER
Sustainable innovation.



MED CAMPUS, Graz – Austria

For those who show the way forward.

Product catalogue
North America 2024/25

Contents

New products	3
Fields of application	4
Material description	5
Hydraulics	6 – 7

BG-FILCOTEN®

8 – 9

self, NW 100	16 – 17
spot	18 – 19
light NW 150	20 – 21
parkline	22 – 23
tec NW 100	24 – 27
pro & pro mini, NW 100	28 – 29
pro & pro mini, NW 150	30 – 31
pro & pro mini, NW 200	32 – 35
pro & pro mini, NW 300	36 – 37
pro, NW 400	38 – 39
connect, NW 100 / 150 / 200 / 300	40 – 41
green, NW 400	42 – 43
light / tec / pro sump units	44 – 45
tec / pro accessories	46
light / tec / pro locking systems for gratings	47
Gratings overview BG-FILCOTEN®	48
one urban, NW 100	50 – 55
one, NW 150 / 200	56 – 61

BG-FLEX

62 – 63

FA facade channel, RB 100	64 – 65
FA facade channel, RB 130	66 – 67
FA facade channel, RB 150	68 – 69
FA facade channel, RB 200	70 – 71
FA facade channel accessories	72 – 73
TE terrace slot channel, SW 18	74
TM terrace channel, RB 60	75
stone, width 150	76 – 77
Special solutions BG-FLEX	78 – 79
omega	80 – 83
sigma tec	84 – 87
Gratings overview BG-FLEX	88 – 89
city grid	90 – 91
Installation examples	92 – 93

Latest NEWS from the Innovations factory...

New products 2024

BG-FILCOTEN[®] connect

This innovative product is used for running cables beneath ground level, making them discreet and accessible – and it does its job perfectly. BG-FILCOTEN[®] connect combines utmost ease of maintenance with a great robustness - ideal for Exhibition and Event Halls as well as Manufacturing Spaces and Industrial Applications. Are you a little curious? Find out more on pages 40 and 41.

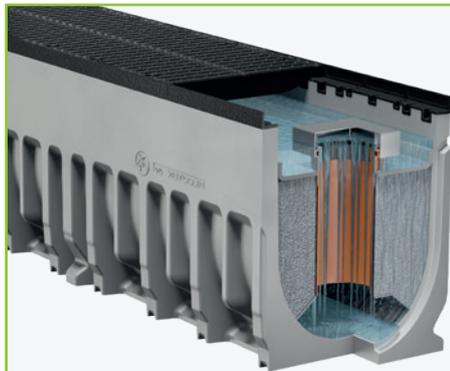
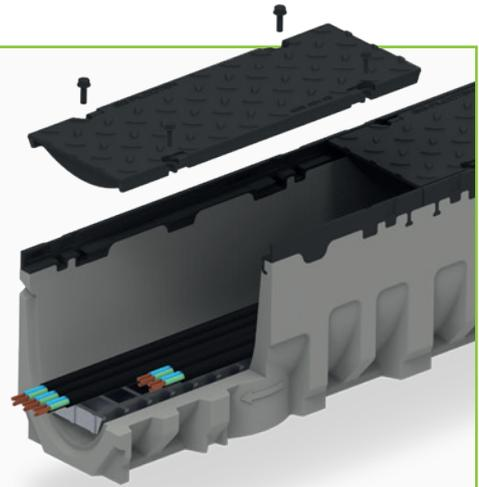

BG-FILCOTEN[®] green

Introducing the BG-FILCOTEN[®] green: A Leap Forward in Sustainable Drainage Solutions. Engineered with filter material, this advanced system offers not only efficient water filtration but also high retention capacity. Uniting sustainability and performance, BG-FILCOTEN[®] green ensures superior protection of the water cycle while meeting the demands of Load Class E 600. A perfect blend of eco-conscious design and technical excellence. More info on pages 42 and 43.

BG-FLEX FA

Our successful BG-FLEX FA stainless steel façade channel drains now has an adapted design and multiple heights for even more flexibility in installation. And so that beauty is not neglected, there is also a new design longitudinal bar grating and other accessories. Are you curious? Then read more on pages 64 to 73.

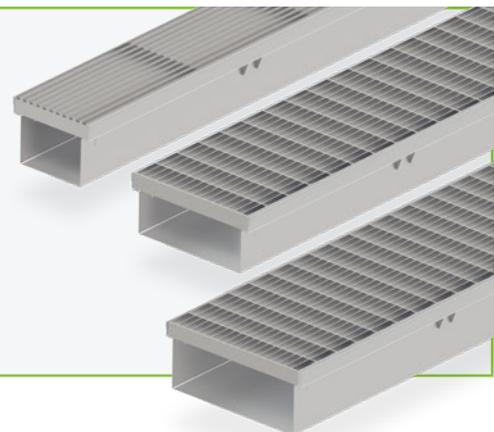

Fields of application

Classification as per EN 1433

Load classes ¹⁾	Application areas	Channel type
 <p>A 15</p>	<p>Traffic areas which are only used by pedestrians and cyclists and similar areas e.g. urban green and open spaces.</p>	<p>self / spot / light 16 – 21 parkline / tec 22 – 27 FA 64 – 73 TE / TM / stone 74 – 77</p>
 <p>B 125</p>	<p>Sidewalks, pedestrian areas and comparable areas, car parks or car parking decks, garages, driveways.</p>	<p>light / spot 18 – 21 parkline 22 – 23 tec 24 – 27 omega / sigma tec 80 – 87</p>
 <p>C 250</p>	<p>Only applies to tops / drainage channels in the curbstone area which may extend 0.5 m into the carriageway and 0.2 m into the pavement, as measured from the curbside, and for roadsides not used by vehicles.</p>	<p>light 20 – 21 parkline 22 – 23 tec / pro 24 – 39 omega / sigma tec 80 – 87</p>
 <p>D 400</p>	<p>Carriageways of roads (including pedestrian zones), road verges, car parks and similar fortified thoroughfares.</p>	<p>pro / connect / green 28 – 43 one urban 50 – 55 one 56 – 61 citygrid 90 – 91</p>
 <p>E 600</p>	<p>Private thoroughfares which are used by vehicles with heavy wheel loads, e.g. routes for industrial construction.</p>	<p>pro 28 – 39 green 42 – 43 one 56 – 61</p>
 <p>F 900</p>	<p>Areas which are used by especially heavy wheel loads, e.g. air traffic areas of commercial airports.</p>	<p>pro 28 – 39 connect 40 – 41 one 56 – 61</p>

¹⁾ Load class in kN

Material description

Properties for material selection



FILCOTEN® HPC

FILCOTEN® HPC (High Performance Concrete) is a material that combines excellent technical properties with sustainability. The optimised high-density micro-structure of the HPC allows the construction of drainage channels in a lightweight design with the same stability and load class as conventional concrete systems. FILCOTEN® HPC is unique when it comes to environmental friendliness thanks to the sparing use of raw materials and due to the fact that it is tested for hazardous materials⁴⁾ guaranteed as harmless in terms of the biological standards of construction, as IBR certified³⁾, 100% recyclable²⁾.

- High-performance mineral concrete (dense, low-capillary, optimized structure)
- High strength and frost resistant
- Fire protection class A1
- Expansion coefficient identical to concrete
- UV resistant
- Compressive strength far exceeding the requirements of EN 1433
- Low water absorption and penetration
- 100% recyclable – quality class U-A²⁾
- IBR certified³⁾, free from: VOCs, styrol⁴⁾ and biozides, heavy metals, radioaktivty

Find more about FILCOTEN® HPC on pages 8 and 9.



Ductile iron

Ductile iron has a high level of resistance against aggressive media such as salt water. The “rust-brown” discolouration of the ductile iron is due to a natural oxidation process and provides protection against further oxidation. The so-called “rust” does not weaken the ground material and does not constitute a reason for a complaint.

Ductile iron gratings with EDP (electrophoretic dip painting) are available at extra cost.



Galvanized steel

Steel parts in the channel systems are coated in a protective zinc coating. To ensure lasting corrosion protection, this layer must itself be protected against mechanical and chemical damage. Contact with calcareous or cement-bound materials (screed, etc.) can destroy or dissolve the protective zinc layer. Condensation also corrodes the protective layer, which results in the formation of white rust formation (corrosion of the zinc layer) – this is not a defect.

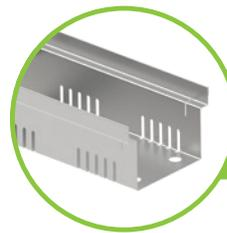

Stainless steel

Contrary to popular belief, stainless steel can corrode. Base metals (in dust or chip form, for example) cause contact corrosion on stainless steel surfaces, forming „rust spots“. Therefore, we recommend storing our stainless steel channels and gratings in a dry place and sorted appropriately. Regular cleaning must be ensured in case of contact with de-icing salt. For our stainless steel edges and gratings, material no. 1.4301 (V2A) is used as standard. Stainless steel gratings made from material no. 1.4571 (V4A) are available at extra cost.

²⁾ Quality class U-A (certified by the BVFS).

³⁾ Meets the strict criteria of the Rosenheim Institute for Building Biology (IBR).

⁴⁾ No use of synthetic resins.

Hydraulics

Shallow channels

Shallow channels										
	up to class C 250 kN			up to class E 600 kN						
Channel type:	city mini 100			pro mini 100		pro mini 150		pro mini 200		pro mini 300
Height:	65 mm			60 mm	80 mm	100 mm	120 mm	100 mm	120 mm	120 mm
Capacity (L/m)	2.7			2.3	4.0	8.3	11.3	11.0	14.9	19.5
Qmax (L/s)	0.4			0.2	0.5	0.9	2.3	1.5	2.2	1.5
Precipitation (L/s ha)	maximum area to be drained (m ²)									
200	20			10	25	45	115	75	110	75
250	16			8	20	36	92	60	88	60
300	13			6	16	30	76	50	73	50
350	11			5	14	25	65	42	62	42
400	10			5	12	22	57	37	55	37

BG-FLEX | Stainless steel channels

BG-FLEX Stainless steel channels										
	Facade channels (walkable and wheelchair-accessible)							up to class C 250 kN		
Channel type:	FA RB 130			FA RB 200		FA RB 250		omega SW 16	sigma tec NW 100	
Height:	50 mm	80 mm	180 mm	50 mm	90 mm	50 mm	90 mm	65 – 200 mm		50 mm
Capacity (L/m)	2.9	5.9	15.9	5.0	12.0	6.8	15.8	2,3 – 10,3		2.8
Qmax (L/s)	0.4	1.5	7.6	0.8	3.8	1.1	4.9	0,2 – 1,9		0.4
Precipitation (L/s ha)	maximum area to be drained (m ²)									
200	20	75	380	40	190	50	240	10 – 95		20
250	16	60	304	32	152	40	190	8 – 76		16
300	13	50	253	26	126	30	160	6,6 – 63		13
350	11	42	217	22	108	30	140	5,7 – 54		11
400	10	37	190	20	95	20	120	5 – 47		10

COMMENT: This average calculation of shallow and steel channels is based on a line length of 10 metres and free runout for each channel type specified. We will be pleased to draft an exact hydraulic calculation adapted to the local conditions for you at any time.

Channels without edges

Channels without edges		
	up to class C 250 kN	
Channel type:	light 150	
Height:	0	10-0
Capacity (L/m)	16.8	24.2
Qmax (L/s)	5.8	11.9
Precipitation (L/s ha)	maximum area to be drained (m ²)	
200	290	590
250	230	470
300	190	390
350	160	340
400	140	290

COMMENT: This average calculation is based on a line length of 20 metres (65.6 ft) and free run-out for each channel type specified. We will be pleased to draft an exact hydraulic calculation adapted to the local conditions for you at any time.

BG-FILCOTEN®-channels with edges

	up to class C 250 kN			up to class E 600 kN												
Channel type:	tec 100		pro 100			pro 150			pro 200			pro 300			pro 400	
Height:	0	10-0	0	10-0	20-0	0	10-0	20-0	0	10-0	20-0	0	10-0	20-0	0	30-0
Capacity (L/m)	8.9	13.9	8.3	12.5	16.5	20.4	26.5	31.8	35.7	43.7	50.8	72.8	85.3	95.9	140.0	200.0
Qmax (L/s)	2.6	5.9	2.5	5.3	10.1	9.6	17.1	25.5	21.0	33.4	46.7	49.4	72.1	96.5	146.0	269.0
Precipitation (L/s ha)	maximum area to be drained (m ²)															
200	130	290	120	260	500	480	850	1270	1050	1670	2330	2470	3600	4820	7300	13450
250	100	230	100	210	400	380	680	1020	840	1330	1860	1970	2880	3860	5840	10760
300	80	190	80	170	330	320	570	850	700	1110	1550	1640	2400	3210	4860	8960
350	70	160	70	150	280	270	480	720	600	950	1330	1410	2060	2750	4170	7680
400	60	140	60	130	250	240	420	630	520	830	1160	1230	1800	2410	3650	6720

BG-FILCOTEN® one urban | BG-FILCOTEN® one

	up to class D 400 kN		up to class F 900 kN			
Channel type:	one urban 100		one 150		one 200	
Height:	0		0	40-0	0	40-0
Capacity (l/m)	15,4		22,0	52,0	37,0	77,0
Qmax (l/s)	6,4		12,5	48,0	22,0	77,0
Precipitation (l/s ha)	maximum area to be drained (m ²)					
200	320		625	2400	1100	3850
250	250		500	1920	880	3080
300	210		416	1600	730	2560
350	180		357	1370	620	2200
400	160		312	1200	550	1920



Our technical support service will be pleased to assist you and to provide you with a hydraulic calculation at any time:
 CA: Phone: +1 514 932-5445 / technical@bg-graspointner.com
 USA: Phone: +1 518 299 1500 / sales.usa@bg-graspointner.com

COMMENT: This average calculation is based on a line length of 20 metres (65.6 ft) and free run-out for each channel type specified. We will be pleased to draft an exact hydraulic calculation adapted to the local conditions for you at any time.

FILCOTEN[®] HPC:

Just like concrete, only better.

The 100% mineral high-performance concrete FILCOTEN[®] HPC is an enhanced form of traditional concrete. Its engineering and ecological properties are achieved without the use of any styrenes, synthetic fibres or polymers. The optimised high-density structure of HPC makes it possible to construct highly stable lightweight drainage channels – but it's the idea behind it that makes it unique.



Minimal weight

- FILCOTEN[®] HPC enables lightweight construction
- Quick and easy to install
- Dimensionally stable, robust concrete elements



Perfect hold in the concrete bed

- Ideal expansion coefficient, identical to that of the surrounding concrete



High drainage performance

- Low water absorption and penetration
- Smooth channel surface for high drainage performance and optimal self-cleaning effect



Resistant to extreme temperatures and UV light

- Maximum resistance to frost and de-icing salt
- UV resistant



Fireproof

- Non-combustible building material – Class A1
- Therefore emits no toxic smoke



Maximum robustness

- Unsurpassed stability and durability
- High pressure resistance, clearly exceeding the requirements of EN 1433 for concrete channels





Verified life cycle assessment (LCA)

- Enhanced ecological transparency, in acc. with ISO 14040/14044 and EN 15804:A2
- Ideal for sustainable construction projects



Resource efficiency

- 100% recyclable, certified
- Quality class U-A ³⁾



Sustainable production

- Resource-efficient manufacturing process
- Up to 70% ⁴⁾ less sand and gravel
- Up to 55% ⁴⁾ less cement
- Up to 51% ⁴⁾ less water



Clean energy for clean products

- Manufactured using 100% green energy
- 17.56% from in-house photovoltaic plant
- No fossil fuels used whatsoever



Certified for sustainability and tested for hazardous substances

- Certified environmental and energy management to ISO 14001 or 50001 standards at the location in Oberwang/AT
- Certified biologically sound construction material that meets the stringent testing criteria of the IBR, the Institute for Biologically Sound Construction, for heavy metals, VOCs, biocides and radioactivity; styrene-free ¹⁾
- certified ²⁾ in acc. too KIWA BRL 5070

¹⁾ Free of synthetic resins. ²⁾ KIWA certificate no. NL BSB® K43940. ³⁾ Certified by the Salzburg Institute for Construction Engineering Research (bvfs)
⁴⁾ Compared to a comparable product made of concrete.



Goodbye greenwashing, hello full transparency.

Today, many companies claim sustainability credentials, but the key question is: how much of this environmental protection is just a green facade?

Full transparency – nature deserves it.

With our BG-FILCOTEN® products, we are following a unique path of total transparency and have subjected the system to a rigorous, independent life cycle analysis ¹⁾. This takes the form of a **Life Cycle Assessment** in line with ISO 14040 & ISO 14044 or EN 15804:A2 and uses recognised indicators such as the Global Warming Potential (GWP), Cumulative Energy Expenditure (CEE) and Abiotic Resource Use (ARU).

We play with our cards on the table – and even let others look over our shoulder.

To confirm our transparent data, the product Life Cycle Assessment for phases A1–A4 was subsequently verified by external experts ²⁾ in line with EN 15804:A2.



Analysed and verified by:

¹⁾ ECODESIGN company – www.ecodesign-company.com

¹⁺²⁾ TerraNEXT – www.terranext.io (verification Q4/2024 completed)



Product life cycle

Phases A1-A4



A1 Raw material sourcing

Extraction and purchase of resources or raw materials.

GWP³⁾ = 71.90 %



A2 Transportation

Delivery of resources and raw materials from the supplier to the manufacturer.

GWP³⁾ = 5.26 %



A3 Production

Production of the product by the manufacturer.

GWP³⁾ = 2.36 %



A4 Transportation

Delivery of the product from the manufacturer to the customer.

GWP³⁾ = 20.48 %



Total GWP³⁾ (Global Warming Potential)

Total global warming potential of phases A1 – A4.

100 % = 42.2 kg CO₂-eq

*) The GWP values are based on one metre of BG-FILCOTEN® one NW 200.

Less raw material consumption fewer CO₂ emissions.

Because sustainability and climate protection start with the material...

A comparison of FILCOTEN® HPC with conventional concrete shows how resources in construction projects can be saved while also having the capacity to significantly reduce CO₂ emissions.

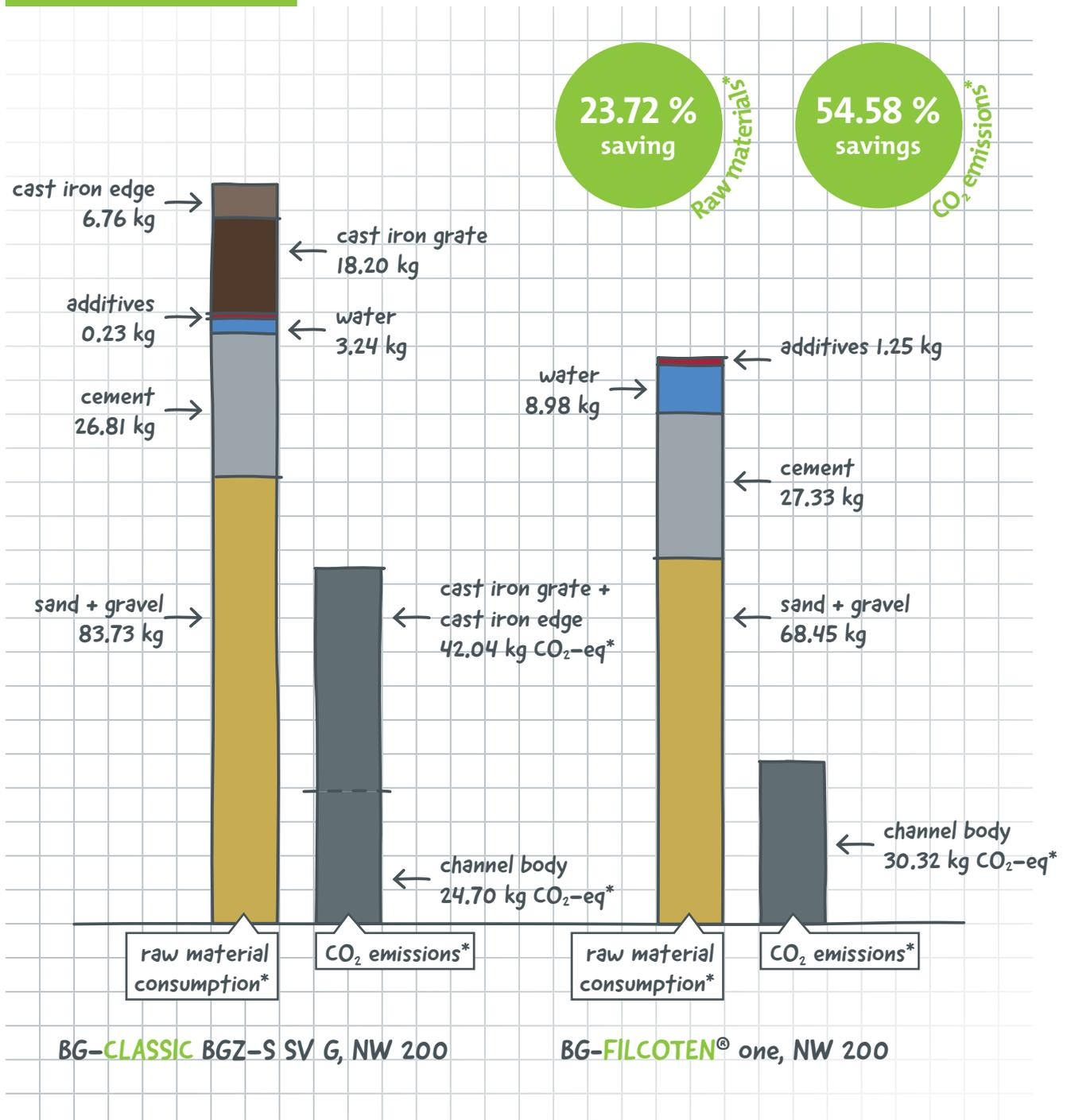

Simply effective and sustainable: The FILCOTEN® HPC formula ...

	NW 200	Global warming potential AI – A4 (500 km Transport)	Total global warming potential for AI – A4 500 m of channel run****
	BG-CLASSIC BGZ-S SV G	79.9 kg CO ₂ -eq**	39,950 kg CO ₂ -eq**
	BG-FILCOTEN® one, no. 0	42.2 kg CO ₂ -eq**	- 21,100 kg CO ₂ -eq**
			= <u>18,850 kg CO₂-eq</u>

A saving of **18,850 kg CO₂ equivalent** equals...



.....75,825 km

...approx. 75,825 km journey of a diesel passenger car (248.6 g/km CO₂-eq)***



.....17,512 km

...approx. 17,512 journey of a 40 tonne semitrailer truck (1,076.4 g/km CO₂-eq)***

***) Value basis LCA environmental indicators according to ISO 14040 and ISO 14044 modules A1-A4 in accordance with EN 15804:A2, BG-Graspointner LCA report 2018, LCA calculator 2023, provided by ECODESIGN company – www.ecodesign-company.com

****) Source: Emission figures of the Austrian Federal Environment Agency, database 2021. Figures used consider total emissions, including statistically average occupancy rates.

*****) Assuming a distance of 500 km to the construction site.

Class A 15 – F 900



Down to the last **detail**
the **top choice**
for **professionals.**

BG-FILCOTEN[®]

Be it regular day-to-day business or special projects involving extreme challenges, BG-FILCOTEN[®] channel systems are in their element on any terrain. After all, these drainage systems represent the high art of engineering and the culmination of many years of experience working to meet the needs and requirements of our customers.

Our FILCOTEN[®] HPC (High Performance Concrete) enables intelligent lightweight construction that affords greater drainage performance, convenient installation and maximum stability and robustness for highly efficient solutions.



GRASPOINTNER
Sustainable innovation.

¹⁾ No use of synthetic resins.



BG-FILCOTEN® self
up to class B 125

pages 16 – 17



BG-FILCOTEN® spot
up to class B 125

pages 18 – 19



BG-FILCOTEN® light
up to class C 250

pages 20 – 21

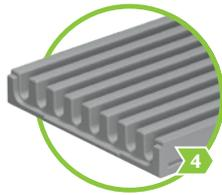

BG-FILCOTEN® parkline
up to class C 250

pages 22 – 23



BG-FILCOTEN® tec
up to class C 250

pages 24 – 27



BG-FILCOTEN® pro mini
up to class E 600

pages 28 – 37



BG-FILCOTEN® pro
up to class F 900

pages 28 – 39



BG-FILCOTEN® connect
up to class F 900

pages 40 – 41



BG-FILCOTEN® green
up to class E 600

pages 42 – 43



BG-FILCOTEN® one urban
up to class D 400

pages 50 – 55



BG-FILCOTEN® one
up to class F 900

pages 56 – 61



Technical data CA: www.say.bg/31/bg-filcoten
Technical data USA: www.say.bg/12/bg-filcoten

BG-FILCOTEN® channel systems sorted by application areas:

Motorway	1 2 3 4 5 6 7 8 9 10 11	Logistics area	1 2 3 4 5 6 7 8 9 10 11
Platform	1 2 3 4 5 6 7 8 9 10 11	Exhibition halls	1 2 3 4 5 6 7 8 9 10 11
Facade	1 2 3 4 5 6 7 8 9 10 11	Parking decks & garages	1 2 3 4 5 6 7 8 9 10 11
Airport (airside)	1 2 3 4 5 6 7 8 9 10 11	Parking area (truck)	1 2 3 4 5 6 7 8 9 10 11
Pedestrian zones	1 2 3 4 5 6 7 8 9 10 11	Parking area (car)	1 2 3 4 5 6 7 8 9 10 11
Garage driveway	1 2 3 4 5 6 7 8 9 10 11	Slot drainage	1 2 3 4 5 6 7 8 9 10 11
Landscape constr.	1 2 3 4 5 6 7 8 9 10 11	Sports facility	1 2 3 4 5 6 7 8 9 10 11
Harbour	1 2 3 4 5 6 7 8 9 10 11	Terrace	1 2 3 4 5 6 7 8 9 10 11
Front entrance	1 2 3 4 5 6 7 8 9 10 11	Underground car park	1 2 3 4 5 6 7 8 9 10 11
Storage area	1 2 3 4 5 6 7 8 9 10 11	Garage	1 2 3 4 5 6 7 8 9 10 11

up to class B 125

BG-FILCOTEN[®] self

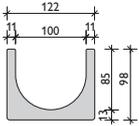

BG-FILCOTEN[®] self, NW 100 mm / 4"

Drainage channel made of FILCOTEN[®] HPC (High Performance Concrete) up to class B, covers lockable

Item no.	SET-item	Load class	Weight	Pc./pallet
10710200	SET self L = 1000 mm incl. slotted grating SW 5/80	accessible by car	8.6 kg	48
Item no.	Accessories	Material	Weight	Pc./pallet
10710290	SET sump unit incl. slotted grating SW 5/80 and silt bucket		17.8 kg	10
10710293	SET sump unit incl. maintenance unit SW 12,5 and silt bucket		21.1 kg	10
19010221	self front cap	galvanized steel	0.1 kg	
19010222	self end cap with outlet	galvanized steel	0.4 kg	
19010290	self conic vertical outlet DN100, for corrugated pipe	galvanized steel	0.3 kg	1

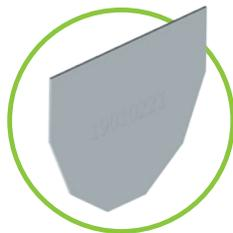

self front cap,
galvanized steel

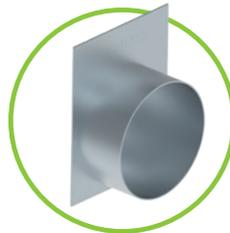

self end cap with outlet,
galvanized steel



self sump unit
L = 500 mm incl. silt bucket
made of plastic



self conic vertical outlet,
galvanized steel



slotted grating SW 5/80,
class C, galvanized steel
& stainless steel

References



up to class B 125

BG-FILCOTEN[®]

spot



BG-FILCOTEN[®] spot

Yard drainage made of FILCOTEN[®] HPC (High Performance Concrete) **incl. ductile iron frame** – up to class B 125

Item no.	spot with ductile iron frame / class A 15 – B 125	L/W/H	Weight	Pcs./Pallet
14130102	spot incl. ductile iron frame, ductile iron grating (EN-GJS) with fix-locking, radial design, odour trap and silt trap	300/300/450	26.7 kg	16

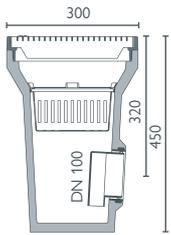

References



up to class C 250

BG-FILCOTEN[®] light



BG-FILCOTEN[®] light, NW 150 mm / 6"

Drainage channel made of FILCOTEN[®] HPC (High Performance Concrete) up to class C, gratings lockable

Item no.	Channel body with safety joint	Slope	Weight	Pcs./Pallet
10315000	light NW 150, no. 0	0.0 %	20.6 kg	20

Gratings and accessories

for BG-FILCOTEN[®] light and light mini, NW 150 mm / 6"

Item no.	Gratings	Load class	Weight	Pc./pallet
17015200	light slotted grating 1000/178/3, SW 8/130	A 15	2.5 kg	128
17015201	light slotted grating 500/178/3, SW 8/130	A 15	1.3 kg	48
17015210	light mesh grating 1000/178/2, MW 30/10	accessible by car	4.6 kg	100
17015211	light mesh grating 500/178/2, MW 30/10	accessible by car	2.3 kg	48
17015100	light ductile iron mesh grating 500/178/7, MW 15/28	C 250	4.6 kg	200

Item no.	Accessories	Material	Weight	Pc./pallet
10315092	light sump unit 500/195/650 incl. pipe coupling DN 150 and plastic sediment bucket	FILCOTEN [®] HPC	45.3 kg	8
19015230	light front/end cap	galvanized steel	0.5 kg	
19015232	light front/end cap with outlet DN 100	galvanized steel	0.4 kg	
19016206	pro no hub bottom outlet 6" (150 mm)	galvanized steel	0.6 kg	

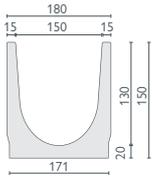

Gratings: BG-FILCOTEN[®] light, NW 150 mm / 6"

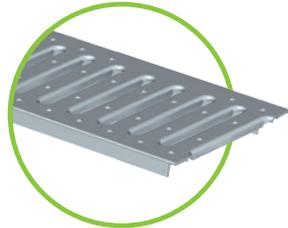

Slotted grating NW 150
SW 8/130,
class A, galvanized steel



Mesh grating
MW 30/10, accessible by car
galvanized steel and stainless steel /
NW 150 galvanized steel only



Ductile iron mesh grating, class C
MW 15/28 for NW 150

Accessories:



No Hub bottom outlet DN 100 to 200
for NW 100 to 300



Bottom outlet on site installation



light sump unit, L = 500 mm,
incl. silt bucket made of plastic,
to fit NW 150



Positioning of outlet drilling: Channel end to outlet opening centre = 250 mm

- a) front cap NW 100 / 150
- b) end cap NW 150 with outlet DN 150
- c) end cap NW 150 with outlet DN 100

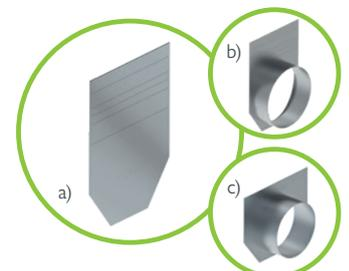

References

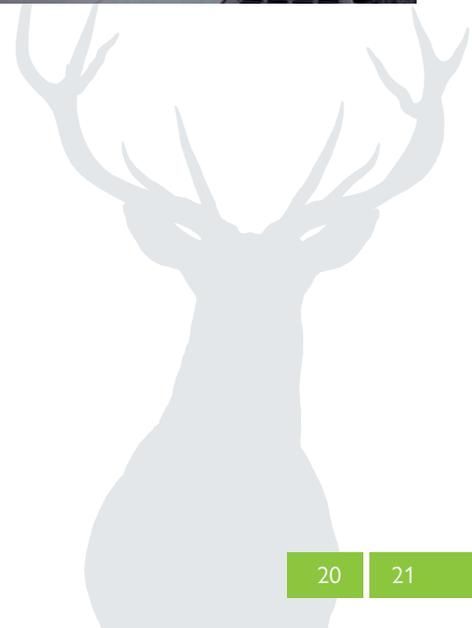

up to class C 250

BG-FILCOTEN® parkline

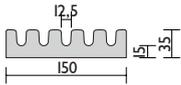
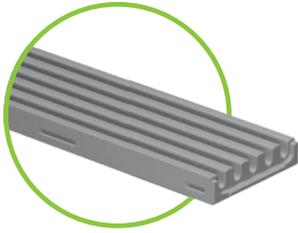

BG-FILCOTEN® parkline, NW 150 mm / 6" – H 35 mm

Channel made of FILCOTEN® HPC (High Performance Concrete) up to class C, capacity: 1,1 L/m

Item no.	Channel body	Slope	Weight	Pcs./Pallet
12515005	parkline 150, H = 35 mm, SW 12.5 mm	0.0 %	9.2 kg	80
12515075	parkline 151, H = 35 mm, SW 12.5 mm, with outlet opening Ø 100	0.0 %	8.9 kg	80
Item no.	Accessories	Material	Weight	Pcs./Pallet
12515084	Cross corner element, 150/150/35 mm, H = 35 mm, SW 12.5 mm	FILCOTEN® HPC	1.3 kg	
12515383	Drain cover, double bridge	stainless steel	0.2 kg	
12515385	Front cap	stainless steel	0.1 kg	
19015926	SET installation supports, size 1, lower section, including nuts ¹⁾	galvanized steel	1.1 kg	
19015927	SET installation supports, size 1, top section, including bolts	galvanized steel	0.4 kg	
12515291	Construction time cover, 1000/150/14 mm	galvanized steel	1.5 kg	
12515392	Cleaning rake (without handle)	stainless steel	0.3 kg	

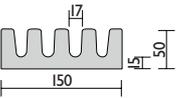

BG-FILCOTEN® parkline, NW 150 mm / 6" – H 50 mm

Channel made of FILCOTEN® HPC (High Performance Concrete) up to class C, capacity: 2,0 L/m

Item no.	Channel body	Slope	Weight	Pcs./Pallet
12515001	parkline 150, H = 50 mm, SW 17 mm	0.0 %	11.9 kg	60
12515071	parkline 151, H = 50 mm, SW 17 mm, with outlet opening Ø 100	0.0 %	11.6 kg	60
Item no.	Accessories	Material	Weight	Pcs./Pallet
12515081	Cross corner element, 150/150/50 mm, H = 50 mm, SW 17 mm	FILCOTEN® HPC	1.8 kg	
12515384	Drain cover	stainless steel	0.1 kg	
12515386	Front cap	stainless steel	0.1 kg	
19015926	SET installation supports, size 1, lower section, including nuts ¹⁾	galvanized steel	1.1 kg	
19015927	SET installation supports, size 1, top section, including bolts	galvanized steel	0.4 kg	
12515292	Construction time cover, 1000/150/14 mm	galvanized steel	1.3 kg	
12515391	Cleaning rake (without handle)	stainless steel	0.2 kg	

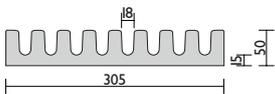
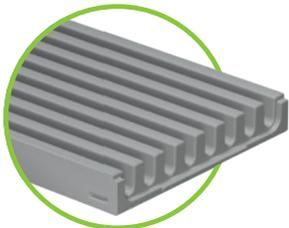

BG-FILCOTEN® parkline, NW 300 mm / 12" – H 50 mm

Channel made of FILCOTEN® HPC (High Performance Concrete) up to class C, capacity: 4,5 L/m

Item no.	Channel body	Slope	Weight	Pcs./Pallet
12530000	parkline 300, H = 50 mm, SW 18 mm	0.0 %	25.3 kg	30
12530070	parkline 301, H = 50 mm, SW 18 mm, with outlet opening Ø 100	0.0 %	25.0 kg	30
Item no.	Accessories	Material	Weight	Pcs./Pallet
12530080	Cross corner element, 300/300/50 mm, H = 50 mm, SW 18 mm	FILCOTEN® HPC	7.6 kg	
12515384	Drain cover	stainless steel	0.1 kg	
12530386	Front cap	stainless steel	0.1 kg	
19030926	SET installation supports, size 3, lower section, including nuts ¹⁾	galvanized steel	1.4 kg	
19030927	SET installation supports, size 3, top section, including bolts	galvanized steel	0.7 kg	
12530291	Construction time cover, 1000/300/20 mm	galvanized steel	2.8 kg	
12530390	Cleaning rake (without handle)	stainless steel	0.5 kg	

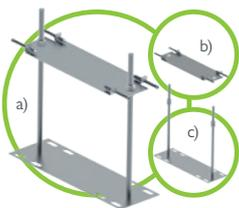

Installation supports, galvanized steel, to match NW

- a) Top part set + lower part set
- b) Top part set incl. bolts
- c) Lower part set incl. nuts



cross element from FILCOTEN® HPC for easy creation of train crossings

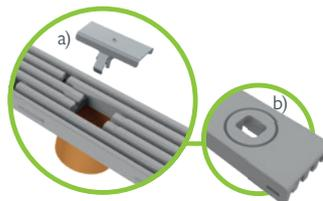

a) Drain cover made of stainless steel
b) Outlet opening



Construction time cover to fit NW made of galvanized steel



front cap

References

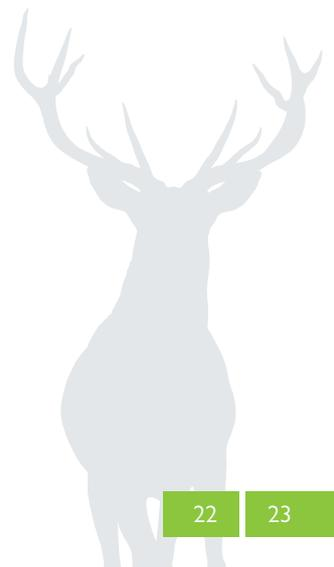

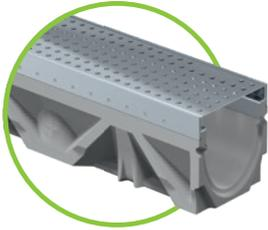

BG-FILCOTEN[®] tec incl. edges, NW 100 mm / 4"

Drainage channel made of FILCOTEN[®] HPC (High Performance Concrete) with integrated galvanized steel (V) or stainless steel edge (E), up to class C

Item no.	Channel body with galvanized steel edge and safety joint	Slope	Weight	Pcs./Pallet
10410200	tec V NW 100, no. 0	0.0 %	13.4 kg	30
10410261	tec V NW 100, no. 5-0	0.0 %	16.1 kg	25
10410262	tec V NW 100, no. 10-0	0.0 %	18.7 kg	25
10410264	tec V NW 100, no. 20-0	0.0 %	28.0 kg	15
10410201-10	tec V NW 100, no. 1 to no. 10	0.5 %	13.4 – 18.5 kg	25
10410211-20	tec V NW 100, no. 11 to no. 20	0.5 %	20.6 – 27.7 kg	15
Item no.	Channel body with stainless steel edge and safety joint	Slope	Weight	Pcs./Pallet
10410300	tec E NW 100, no. 0	0.0 %	13.4 kg	30
10410361	tec E NW 100, no. 5-0	0.0 %	16.1 kg	25
10410362	tec E NW 100, no. 10-0	0.0 %	18.7 kg	25
10410364	tec E NW 100, no. 20-0	0.0 %	28.0 kg	15
10410301-10	tec E NW 100, no. 1 to no. 10	0.5 %	13.4 – 18.5 kg	25
10410311-20	tec E NW 100, no. 11 to no. 20	0.5 %	20.6 – 27.7 kg	15

Channels no. 0-10:

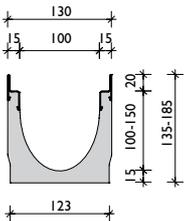

Channels no. 11-20:

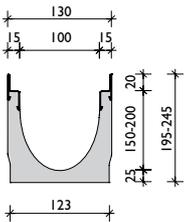

In-/Outlet cross-section

If channel runs have a line length of more than 2 meters, the water flows off just as well with a slot top as with a classic cover.

The reason:

The inlet cross-section of the slot top is – as the inlet cross-section of a classic cover – larger than the flow cross-section of the connected sewer pipe. The amount of draining water is limited by the drainpipe and not by the inlet cross sections of the cover.

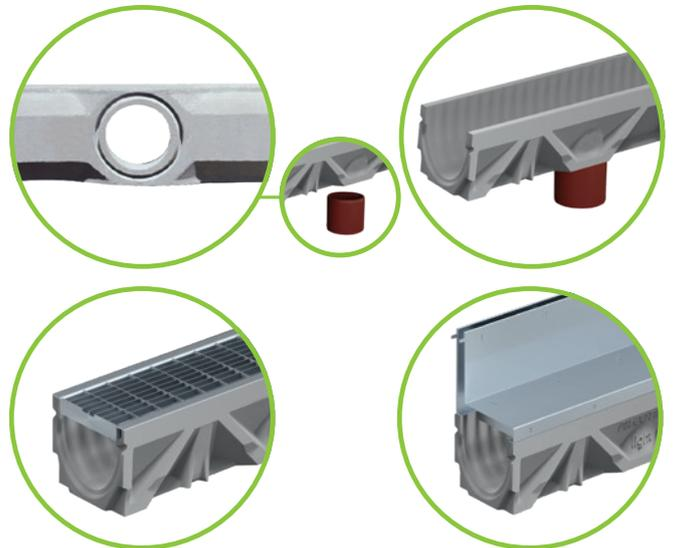

Channel body with outlet opening

The position of the outlet opening and/or the lateral drill-hole (left/right) can be freely selected for 5-0 channels.

Maximum lateral drilling diameter:
- with NW 100 \varnothing 86 mm

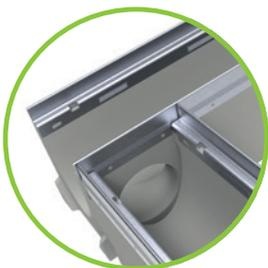

For questions, please contact our technical support team.

Gratings and accessories

for BG-FILCOTEN® tec and tec mini with galvanized steel (V)
or stainless steel edge (E), NW 100 mm / 4"

Item no.			Covers with fiX-locking (no bolt connection)	Load class	Weight	Pc./pallet
17010220		✓	tec mesh grating 1000/122/20, MW 30/10	B 125	2.8 kg	120
17010221		✓	tec mesh grating 500/122/20, MW 30/10	B 125	1.4 kg	48
17010222		✓	tec mesh grating 1000/122/20, MW 30/10	C 250	3.3 kg	120
17010223		✓	tec mesh grating 500/122/20, MW 30/10	C 250	1.6 kg	48
17010322		✓	tec mesh grating 1000/122/20, MW 30/10, stainless steel	C 250	3.3 kg	120
17010323		✓	tec mesh grating 500/122/20, MW 30/10, stainless steel	C 250	1.6 kg	48
17010202		✓	tec slotted grating 1000/122/20, SW 8/80 ³⁾	A 15	1.5 kg	120
17010203		✓	tec slotted grating 500/122/20, SW 8/80 ³⁾	A 15	0.8 kg	48
17010206		✓	tec slotted grating 1000/122/20, SW 8/80 ³⁾	C 250	4.5 kg	60
17010207		✓	tec slotted grating 500/122/20, SW 8/80 ³⁾	C 250	2.2 kg	48
17010302		✓	tec slotted grating 1000/122/20, SW 8/80, stainless steel V2A ³⁾	A 15	1.5 kg	120
17010303		✓	tec slotted grating 500/122/20, SW 8/80, stainless steel V2A ³⁾	A 15	0.8 kg	48
17010306		✓	tec slotted grating 1000/122/20, SW 8/80, stainless steel V2A ³⁾	C 250	4.5 kg	120
17010307		✓	tec slotted grating 500/122/20, SW 8/80, stainless steel V2A ³⁾	C 250	2.2 kg	48
<i>tec slotted gratings on request in stainless steel available.</i>						
17010204	✓	✓	tec perforated grating 1000/122/20, Ø 6.0 mm	A 15	1.9 kg	120
17010205	✓	✓	tec perforated grating 500/122/20, Ø 6.0 mm	A 15	1.0 kg	48
17010228	✓	✓	tec perforated grating 1000/122/20, Ø 6.0 mm	C 250	3.3 kg	96
17010229	✓	✓	tec perforated grating 500/122/20, Ø 6.0 mm	C 250	1.7 kg	48
17010304	✓	✓	tec perforated grating 1000/122/20, Ø 6.0 mm, stainless steel V2A	A 15	1.9 kg	120
17010305	✓	✓	tec perforated grating 500/122/20, Ø 6.0 mm, stainless steel V2A	A 15	1.0 kg	48
17010328	✓	✓	tec perforated grating 1000/122/20, Ø 6.0 mm, stainless steel V2A	C 250	3.3 kg	120
17010329	✓	✓	tec perforated grating 500/122/20, Ø 6.0 mm, stainless steel V2A	C 250	1.7 kg	48
<i>tec slotted gratings on request in stainless steel available.</i>						
17010401	✓	✓	tec COMBee design grating 500/123/20, Ø 7,3 mm, plastic PA6 ³⁾	B 125	0.9 kg	160
17010402	✓	✓	tec COMBee design grating 500/123/20, Ø 7,3 mm, plastic PA6 ³⁾	C 250	1.1 kg	160
17010403	✓	✓	tec COMTread design slotted grating 500/123/20, SW 8/40, plastic PA6	B 125	0.9 kg	160
17010404	✓	✓	tec COMTread design slotted grating 500/123/20, SW 8/40, plastic PA6	C 250	1.1 kg	160
17010105		✓	tec ductile iron slotted grating 500/122/20, MW 14/100	E 600	3.8 kg	240
17010106	✓	✓	tec ductile iron elongated bar grating 500/122/20, MW 29/6, narrow SW	C 250	3.6 kg	240
17010110		✓	tec ductile iron elongated bar grating 500/122/20, MW 28/9	D 400	3.4 kg	240
17010180	✓	✓	tec ductile iron design grating „VILLE“ 500/122/25	E 600	5.2 kg	240
17010183	✓	✓	tec ductile iron design grating „KIARO“ 500/122/25	D 400	4.1 kg	240
17010184	✓	✓	tec ductile iron design grating „VIA“ 500/122/25	D 400	3.6 kg	240
<i>tec design gratings – different designs ³⁾ see pro design gratings NW 100</i>						
32087			tec anti-vandalism locking device Requirement: 2 pieces per cover	stainless steel	0.1 kg	
Item no.   BG-FILCOTEN® slot tops V asymmetric incl. accessories						
17111204	✓	✓	Slot top 2S, Heelproof V NW 100, 1000/123/133, SH 110, SW 2x6 mm	C 250	5.8 kg	36
17111205	✓	✓	Slot top 2S, Heelproof V NW 100, 500/123/133, SH 110, SW 2x6 mm	C 250	3.0 kg	24
17111206	✓	✓	Maintenance unit 2S, Heelproof V NW 100, 500/123/133, SH 110, SW 2x6 mm	C 250	5.3 kg	24
13399			Opening tool for maintenance unit cover – 2 pcs. required, plastic		0.1 kg	
Item no.   BG-FILCOTEN® slot tops E asymmetric incl. accessories						
17111304	✓	✓	Slot top 2S, Heelproof E NW 100, 1000/123/133, SH 110, SW 2x6 mmv	C 250	5.8 kg	36
17111305	✓	✓	Slot top 2S, Heelproof E NW 100, 500/123/133, SH 110, SW 2x6 mmv	C 250	3.0 kg	24
17111306	✓	✓	Maintenance unit 2S, Heelproof E NW 100, 500/123/133, SH 110, SW 2x6 mm	C 250	5.3 kg	24
13399			Opening tool for maintenance unit cover – 2 pcs. required, plastic		0.1 kg	
Item no. Accessories						
10410294			tec sump unit V 500/144/500 incl. pipe coupling Ø 100 and plastic sediment bucket	FILCOTEN® HPC	24.2 kg	10
10410394			tec sump unit E 500/144/500 incl. pipe coupling Ø 100 and plastic silt bucket ¹⁾	FILCOTEN® HPC	24.2 kg	10
19010400			tec front/end cap with outlet Ø 100	plastic	0.1 kg	
19010295			tec step displace plate NW 100, Nr. 0-20/0	galvanized steel	0.1 kg	
19010902			tec rebar support	galvanized steel	0.6 kg	
19011204			tec no hub bottom outlet	galvanized steel	0.3 kg	

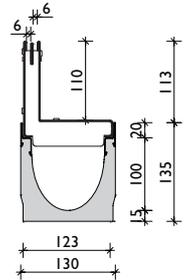

Slot top 2S,
Heelproof
SW 2x6, class C

NEW
NEW

i Slot tops symmetric, for load class D 400 or special parts on request.
Installation guidelines at www.bg-graspoinner.com

 Complies with ASME:A112.6.8 Heel-Resistant Grates

 Complies with ADA - American Disabilities Act

Gratings: BG-FILCOTEN[®] tec and tec mini NW 100 mm / 4"



Slotted grating, class A and C
galvanized steel / stainless steel,
SW 8/80 for NW 100



Mesh grating, cl. B – galvanized steel and
class C galvanized steel / stainless steel,
MW 30/10, for NW 100



Perforated grating
galvanized steel / stainless steel, Ø 6.0 mm
Class A and class C for NW 100



Slot top
SW 12.5 mm, class C, NW 100, V & E
2S, SW 2x6 mm C, NW 100, V &, E



Ductile iron elongated bar
grating MW 28/9, cl. D
for NW 100



Ductile iron elongated bar grating
MW 29/6 narrow SW, cl. C
for NW 100



Ductile iron slotted
grating SW 14/100, cl. E
for NW 100



Ductile iron "KIARO"
grating SW 7 mm, cl. D
for NW 100



COMBee design grating
Ø 7,3 mm, cl. C
plastic PA6
for NW 100



COMTread design grating
SW 8/40, c. C
plastic PA6
for NW 100



Ductile iron "VIA"
grating SW 7 mm, cl. D
for NW 100



Ductile iron "VILLE"
grating SW 8 mm, cl. E
for NW 100

References

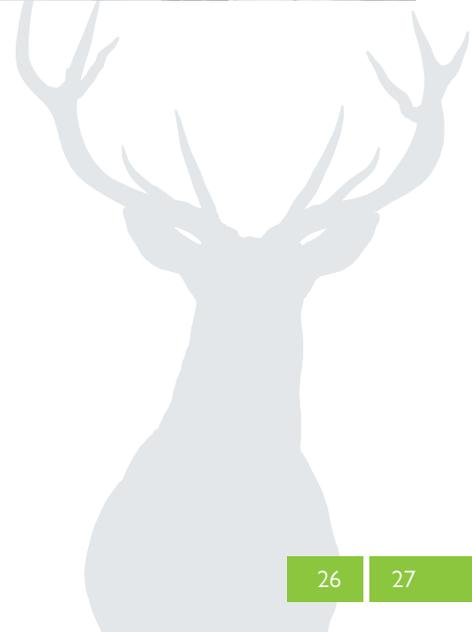
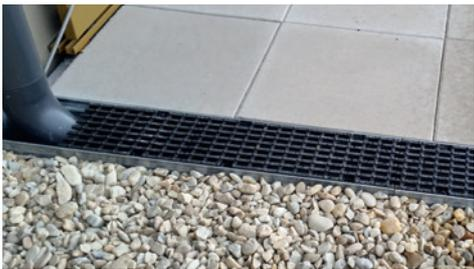

up to class F 900

BG-FILCOTEN[®]

pro

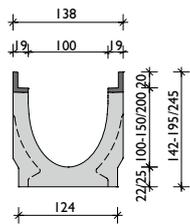

Ductile iron edge

BG-FILCOTEN[®] pro incl. edges, NW 100 mm / 4"

Drainage channel made of FILCOTEN[®] HPC (High Performance Concrete) with integrated cast iron (G), galvanized steel (V) or stainless steel edge (E), up to class F

Item no.	Channel body with ductile iron edge and safety joint	Slope	Weight	Pcs./Pallet
10610100	pro G NW 100, no. 0 ¹⁾	0.0 %	20.5 kg	25
10610161	pro G NW 100, no. 5-0 ¹⁾	0.0 %	22.6 kg	20
10610162	pro G NW 100, no. 10-0 ¹⁾	0.0 %	26.1 kg	20
10610164	pro G NW 100, no. 20-0 ¹⁾	0.0 %	32.0 kg	15
10610101-10	pro G NW 100, no. 1 to no. 10 ¹⁾	0.5 %	19.5 – 25.4 kg	20

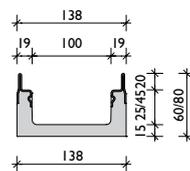

galvanized steel
or stainless steel edge

BG-FILCOTEN[®] pro mini incl. edges, NW 100 mm / 4"

Drainage channel made of FILCOTEN[®] HPC (High Performance Concrete) with integrated cast iron (G), galvanized steel (V) or stainless steel edge (E), up to class F – very low construction height

Item no.	Channel body with galvanized steel edge and safety joint	Slope	Weight	Pcs./Pallet
10510200	pro V mini NW 100, H = 60 mm	0.0 %	9.1 kg	50
10510201	pro V mini NW 100, H = 80 mm	0.0 %	11.2 kg	40
Item no.	Channel body with stainless steel edge and safety joint	Slope	Weight	Pcs./Pallet
10510300	pro E mini NW 100, H = 60 mm ¹⁾	0.0 %	9.1 kg	50
10510301	pro E mini NW 100, H = 80 mm ¹⁾	0.0 %	11.2 kg	40

Gratings and accessories

for BG-FILCOTEN® pro and pro mini with cast iron edge (G), galvanized steel (V) or stainless steel edge (E), NW 100 mm / 4"

Item no.		Covers with fiX-locking (no bolt connection)	Load class	Weight	Pcs./Pallet
17010220	✓	pro mesh grating 1000/122/20, MW 30/10	B 125	2.8 kg	120
17010221	✓	pro mesh grating 500/122/20, MW 30/10	B 125	1.4 kg	48
17010222	✓	pro mesh grating 1000/122/20, MW 30/10	C 250	3.3 kg	120
17010223	✓	pro mesh grating 500/122/20, MW 30/10	C 250	1.6 kg	48
17010322	✓	pro mesh grating 1000/122/20, MW 30/10, stainless steel ¹⁾	C 250	3.3 kg	120
17010323	✓	pro mesh grating 500/122/20, MW 30/10, stainless steel ¹⁾	C 250	1.6 kg	48
17010226	✓	pro mesh grating 1000/122/20, MW 25/10 ¹⁾	D 400	7.4 kg	96
17010227	✓	pro mesh grating 500/122/20, MW 25/10 ¹⁾	D 400	3.8 kg	48
17010326	✓	pro mesh grating 1000/122/20, MW 25/10, stainless steel ¹⁾	D 400	7.4 kg	96
17010327	✓	pro mesh grating 500/122/20, MW 25/10, stainless steel ¹⁾	D 400	3.8 kg	48
17010206	✓	pro slotted grating 1000/122/20, SW 8/80 ^{1) 3)}	C 250	4.5 kg	60
17010207	✓	pro slotted grating 500/122/20, SW 8/80 ^{1) 3)}	C 250	2.2 kg	48
17010306	✓	pro slotted grating 1000/122/20, SW 8/80, AISI 304 ^{1) 3)}	C 250	4.5 kg	60
17010307	✓	pro slotted grating 500/122/20, SW 8/80, stainless steel ^{1) 3)}	C 250	2.2 kg	48
17010228	✓	pro perforated grating 1000/122/20, Ø 6.0 mm	C 250	3.3 kg	96
17010229	✓	pro perforated grating 500/122/20, Ø 6.0 mm	C 250	1.7 kg	48
17010328	✓	pro perforated grating 1000/122/20, Ø 6.0 mm, stainless steel ¹⁾	C 250	3.3 kg	96
17010329	✓	pro perforated grating 500/122/20, Ø 6.0 mm, stainless steel ¹⁾	C 250	1.7 kg	48
17010401	✓	tec COMBee design grating 500/123/20, Ø 7,3 mm, plastic PA6 ³⁾	B 125	0.9 kg	160
17010402	✓	tec COMBee design grating 500/123/20, Ø 7,3 mm, plastic PA6 ³⁾	C 250	1.1 kg	160
17010403	✓	tec COMTread design slotted grating 500/123/20, SW 8/40, plastic PA6	B 125	0.9 kg	160
17010404	✓	tec COMTread design slotted grating 500/123/20, SW 8/40, plastic PA6	C 250	1.1 kg	160
17010105	✓	pro ductile iron slotted grating 500/122/20, SW 14/100	E 600	3.8 kg	240
17010106	✓	pro ductile iron elongated bar grating 500/122/20, MW 29/6, narrow SW	C 250	3.6 kg	240
17010110	✓	pro ductile iron elongated bar grating 500/122/20, MW 28/9	D 400	3.4 kg	240
17010180	✓	pro ductile iron design grating "VILLE" 500/122/20, SW 7 ¹⁾	E 600	5.2 kg	240
17010183	✓	pro ductile iron design grating "KIARO" 500/122/20, SW 7 ^{1) 3)}	D 400	4.1 kg	240
17010184	✓	pro ductile iron design grating "VIA" 500/122/20, SW 7 ^{1) 3)}	D 400	3.6 kg	240
32087		pro anti-vandalism locking device Requirement: 2 pieces per cover	stainless steel	0.1 kg	
Item no.		Gratings 4 point boltable (only in cast iron edge)	Load class	Weight	Pcs./Pallet
17010103	✓	pro ductile iron elongated bar grating 500/122/20, MW 22/13 ^{3) 4)}	E 600	4.2 kg	240
17010107	✓	pro ductile iron slotted grating 500/122/20, SW 14/100	F 900	4.8 kg	192
17010113	✓	pro ductile iron cover, closed, 500/122/20 ^{1) 3)}	E 600	5.3 kg	168
32103		pro bolting material for ductile iron gratings Cl. E (1 pc. bolt, 1 pc. nut – 8 pcs. required per m)			
32109		pro bolting material stainless steel, for ductile iron grating class E (1 pc. bolt, 1 pc. nut – 8 pcs. required per m)			
Item no.	Accessories	Material	Weight	Pcs./Pallet	
10610192	pro sump unit G 500/145/600 incl. pipe coupling Ø 100 and plastic sediment bucket	FILCOTEN® HPC	33.1 kg	10	
19010400	pro front/end cap with outlet Ø 100	plastic	0.1 kg		
19010200	pro mini front cap	galvanized steel	0.1 kg		
19010295	pro step displace plate NW 100, Nr. 0-20/0	galvanized steel	0.1 kg		
19010902	pro rebar support NW 100	galvanized steel	0.6 kg		
19011204	pro no hub bottom outlet 4" (100 mm)	galvanized steel	0.3 kg		

NEW

NEW

NEW

 Complies with ASME:A112.6.8 Heel-Resistant Grates

 Complies with ADA - American Disabilities Act

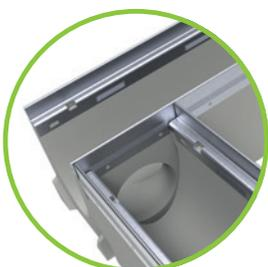

Channel body with outlet opening

The position of the outlet opening and/or the lateral drill-hole (left/right) can be freely selected for 5-0 channels.

Maximum lateral drilling diameter:

- with NW 100 Ø 86 mm
- with NW 150 Ø 130 mm
- with NW 200 Ø 180 mm



For questions, please contact our technical support team.

up to class F 900

BG-FILCOTEN® pro

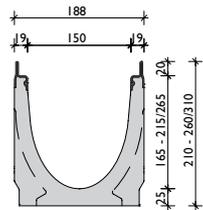

galvanized steel
or stainless steel edge

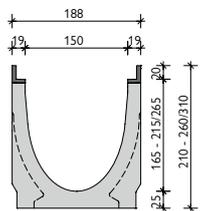

Ductile iron edge

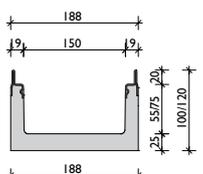

galvanized steel
or stainless steel edge

BG-FILCOTEN® pro incl. edges, NW 150 mm / 6"

Drainage channel made of FILCOTEN® HPC (High Performance Concrete) with integrated cast iron (G), galvanized steel (V) or stainless steel edge (E), up to class F

Item no.	Channel body with galvanized steel edge and safety joint	Slope	Weight	Pcs./Pallet
10615200	pro V NW 150, no. 0	0.0 %	31.7 kg	16
10615261	pro V NW 150, no. 5-0	0.0 %	34.6 kg	12
10615262	pro V NW 150, no. 10-0	0.0 %	39.5 kg	12
10615264	pro V NW 150, no. 20-0	0.0 %	48.5 kg	8
10615201-10	pro V NW 150, no. 1 to no. 10	0.5 %	31.5 – 37.5 kg	12
Item no.	Channel body with ductile iron edge and safety joint	Slope	Weight	Pcs./Pallet
10615100	pro G NW 150, no. 0	0.0 %	32.5 kg	16
10615161	pro G NW 150, no. 5-0	0.0 %	35.6 kg	12
10615162	pro G NW 150, no. 10-0	0.0 %	40.0 kg	12
10615164	pro G NW 150, no. 20-0	0.0 %	50.5 kg	8
10615101-10	pro G NW 150, no. 1 to no. 10	0.5 %	32.5 – 38.5 kg	12
Item no.	Channel body with stainless steel edge and safety joint	Slope	Weight	Pcs./Pallet
10615300	pro E NW 150, no. 0 ¹⁾	0.0 %	30.8 kg	16
10615361	pro E NW 150, no. 5-0	0.0 %	34.6 kg	12
10615362	pro E NW 150, no. 10-0 ¹⁾	0.0 %	37.8 kg	12
10615364	pro E NW 150, no. 20-0	0.0 %	47.7 kg	8
10615301-10	pro E NW 150, no. 1 to no. 10 ¹⁾	0.5 %	31.5 – 37.5 kg	12

BG-FILCOTEN® pro mini incl. edges, NW 150 mm / 6"

Drainage channel made of FILCOTEN® HPC (High Performance Concrete) with integrated, galvanized steel (V) or stainless steel edge (E) up to class F – very low construction height

Item no.	Channel body with galvanized steel edge and safety joint	Slope	Weight	Pcs./Pallet
10515202	pro V mini NW 150, H = 100 mm	0.0 %	18.9 kg	24
10515200	pro V mini NW 150, H = 120 mm ¹⁾	0.0 %	20.2 kg	20
Item no.	Channel body with stainless steel edge and safety joint	Slope	Weight	Pcs./Pallet
10515302	pro E mini NW 150, H = 100 mm ¹⁾	0.0 %	18.9 kg	24
10515300	pro E mini NW 150, H = 120 mm ¹⁾	0.0 %	20.2 kg	20

Gratings and accessories

for BG-FILCOTEN® pro and pro mini with cast iron edge (G), galvanized steel (V) or stainless steel edge (E),
NW 150 mm / 6"

Item no.			Covers with fiX-locking (no bolt connection)	Load class	Weight	Pcs./Pallet
17015220		✓	pro mesh grating 1000/172/20, MW 30/10	B 125	4.6 kg	68
17015221		✓	pro mesh grating 500/172/20, MW 30/10	B 125	2.4 kg	48
17015222		✓	pro mesh grating 1000/172/20, MW 30/10	C 250	6.9 kg	68
17015223		✓	pro mesh grating 500/172/20, MW 30/10	C 250	3.6 kg	48
17015322		✓	pro mesh grating 1000/172/20, MW 30/10, stainless steel ¹⁾	C 250	6.9 kg	68
17015323		✓	pro mesh grating 500/172/20, MW 30/10, stainless steel ¹⁾	C 250	3.6 kg	48
17015226		✓	pro mesh grating 1000/172/20, MW 25/10 ¹⁾	D 400	10.4 kg	68
17015227		✓	pro mesh grating 500/172/20, MW 25/10 ¹⁾	D 400	5.3 kg	48
17015228	✓	✓	pro perforated grating 1000/172/20, Ø 6.0 mm	C 250	10.0 kg	40
17015229	✓	✓	pro perforated grating 500/172/20, Ø 6.0 mm	C 250	5.0 kg	28
17015328	✓	✓	pro perforated grating 1000/172/20, Ø 6.0 mm, stainless steel ¹⁾	C 250	10.0 kg	40
17015329	✓	✓	pro perforated grating 500/172/20, Ø 6.0 mm, stainless steel ¹⁾	C 250	5.0 kg	28
17015104		✓	pro ductile iron elongated bar grating 500/172/20, MW 29/13	D 400	5.5 kg	128
17015105		✓	pro ductile iron slotted grating 500/172/20, SW 14/150	E 600	5.5 kg	96
17015183	✓	✓	pro ductile iron design grating "KIARO" 500/172/20, SW 7 ^{1) 3)}	D 400	6.0 kg	128
17015184	✓	✓	pro ductile iron design grating "VIA" 500/172/20, SW 7 ^{1) 3)}	D 400	5.6 kg	128
17015180	✓	✓	pro ductile iron design grating "VILLE" 500/172/20, SW 7 ¹⁾	E 600	8.6 kg	128
32088			pro anti-vandalism locking device Requirement: 2 pieces per cover	stainless steel	0.1 kg	
Item no.			Gratings 4 point boltable (only in cast iron edge)	Load class	Weight	Pcs./Pallet
17015103		✓	pro ductile iron elongated bar grating 500/172/20, MW 22/13 ^{3) 4)}	E 600	7.2 kg	128
17015107		✓	pro ductile iron slotted grating NW 150, 500/172/20, SW 14/150 ⁴⁾	F 900	7.3 kg	96
17015113	✓	✓	pro ductile iron cover, closed, 500/172/20 ^{3) 1)}	E 600	7.9 kg	96
32103			pro locking device kit for ductile iron grating class D and E (1 pc. bolt, 1 pc. nut – 8 pcs. required per m)			
32109			pro locking device kit stainless steel for ductile iron grating class D and E (1 pc. bolt, 1 pc. nut – 8 pcs. required per m)			
Item no.	Accessories		Material	Weight	Pcs./Pallet	
10615192	pro sump unit G 500/200/690 incl. pipe coupling Ø 150 and plastic sediment bucket		FILCOTEN® HPC	45.3 kg	8	
10615292	pro sump unit V 500/200/690 incl. pipe coupling Ø 150 and plastic sediment bucket		FILCOTEN® HPC	44.8 kg	8	
10615392	pro sump unit E 500/200/690 incl. pipe coupling Ø 150 and plastic silt trap ¹⁾		FILCOTEN® HPC	44.8 kg	8	
19015215	pro front cap (no. 20-0)		galvanized steel	0.6 kg		
19015216	pro end cap with outlet Ø 150 (no. 20-0)		galvanized steel	0.7 kg		
19015200	pro mini front cap (H = 100 und H = 120 mm)		galvanized steel	0.3 kg		
19015295	pro step displace plate NW 150, Nr. 0-20/0		galvanized steel	0.2 kg		
19016206	pro no hub bottom outlet 6" (150 mm)		galvanized steel	0.6 kg		
19020902	pro rebar support NW 150-200		galvanized steel	0.8 kg		

NEW

 Complies with ASME: A11.2.6.8 Heel-Resistant Grates

 Complies with ADA - American Disabilities Act



up to class F 900

BG-FILCOTEN[®] pro

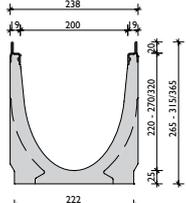
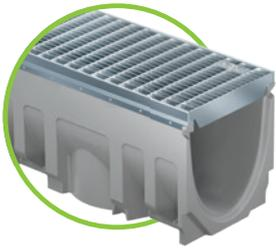

galvanized steel
or stainless steel edge

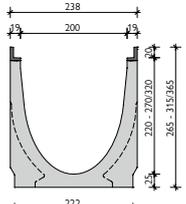
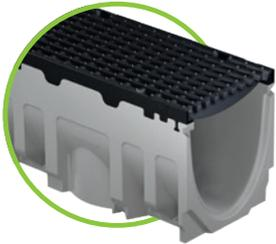

Ductile iron edge

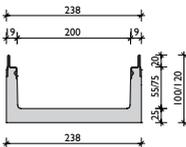

galvanized steel
or stainless steel edge

BG-FILCOTEN[®] pro incl. edges, NW 200 mm / 8"

Drainage channel made of FILCOTEN[®] HPC (High Performance Concrete) with integrated cast iron (G), galvanized steel (V) or stainless steel edge (E), up to class F

Item no.	Channel body with galvanized steel edge and safety joint	Slope	Weight	Pcs./Pallet
10620200	pro V NW 200, no. 0	0.0 %	44.0 kg	9
10620261	pro V NW 200, no. 5-0	0.0 %	49.3 kg	6
10620262	pro V NW 200, no. 10-0	0.0 %	54.3 kg	6
10620264	pro V NW 200, no. 20-0	0.0 %	64.6 kg	6
10620201-10	pro V NW 200, no. 1 to no. 10	0.5 %	44.5 – 53.9 kg	6
10620211-20	pro V NW 200, no. 11 to no. 20	0.5 %	55.3 – 65.7 kg	6
Item no.	Channel body with ductile iron edge and safety joint	Slope	Weight	Pcs./Pallet
10620100	pro G NW 200, no. 0	0.0 %	45.0 kg	9
10620161	pro G NW 200, no. 5-0	0.0 %	50.3 kg	6
10620162	pro G NW 200, no. 10-0	0.0 %	55.3 kg	6
10620164	pro G NW 200, no. 20-0	0.0 %	65.6 kg	6
10620101-10	pro G NW 200, no. 1 to no. 10	0.5 %	45.5 – 54.9 kg	6
10620111-20	pro V NW 200, no. 11 to no. 20	0.5 %	55.3 – 65.7 kg	6
Item no.	Channel body with stainless steel edge and safety joint	Slope	Weight	Pcs./Pallet
10620300	pro E NW 200, no. 0 ¹⁾	0.0 %	44.0 kg	9
10620361	pro E NW 200, no. 5-0	0.0 %	49.3 kg	6
10620362	pro E NW 200, no. 10-0 ¹⁾	0.0 %	54.3 kg	6
10620364	pro E NW 200, no. 20-0	0.0 %	62.7 kg	6
10620301-10	pro E NW 200, no. 1 to no. 10 ¹⁾	0.5 %	44.5 – 53.9 kg	6
10620311-20	pro E NW 200, no. 11 to no. 20	0.5 %	55.3 – 65.7 kg	6

BG-FILCOTEN[®] pro mini incl. edges, NW 200 mm / 8"

Drainage channel made of FILCOTEN[®] HPC (High Performance Concrete) with integrated cast iron (G), galvanized steel (V) or stainless steel edge (E) up to class F – very low construction height

Item no.	Channel body with galvanized steel edge and safety joint	Slope	Weight	Pcs./Pallet
10520202	pro V mini NW 200, H = 100 mm	0.0 %	21.3 kg	24
10520200	pro V mini NW 200, H = 120 mm ¹⁾	0.0 %	23.2 kg	18
Item no.	Channel body with stainless steel edge and safety joint	Slope	Weight	Pcs./Pallet
10520302	pro E mini NW 200, H = 100 mm ¹⁾	0.0 %	21.3 kg	24
10520300	pro E mini NW 200, H = 120 mm ¹⁾	0.0 %	23.2 kg	18

Gratings and accessories

for BG-FILCOTEN® pro and pro mini with cast iron edge (G), galvanized steel (V) or stainless steel edge (E), NW 200 mm / 8"

Item no.		Covers with fiX-locking (no bolt connection)	Load class	Weight	Pcs./Pallet
17020220	✓	pro mesh grating 1000/222/20, MW 30/10	B 125	6.0 kg	60
17020221	✓	pro mesh grating 500/222/20, MW 30/10	B 125	3.1 kg	28
17020222	✓	pro mesh grating 1000/222/20, MW 30/10	C 250	8.8 kg	60
17020223	✓	pro mesh grating 500/222/20, MW 30/10	C 250	4.5 kg	28
17020322	✓	pro mesh grating 1000/222/20, MW 30/10, stainless steel ¹⁾	C 250	8.8 kg	60
17020323	✓	pro mesh grating 500/222/20, MW 30/10, stainless steel ¹⁾	C 250	4.5 kg	28
17020226	✓	pro mesh grating 1000/222/20, MW 25/10 ¹⁾	D 400	15.7 kg	30
17020227	✓	pro mesh grating 500/222/20, MW 25/10 ¹⁾	D 400	8.0 kg	21
17020228	✓	pro perforated grating 1000/222/20, Ø 6.0 mm ¹⁾	C 250	13.5 kg	60
17020229	✓	pro perforated grating 500/222/20, Ø 6.0 mm ¹⁾	C 250	6.7 kg	28
17020328	✓	pro perforated grating 1000/222/20, Ø 6.0 mm, stainless steel ¹⁾	C 250	13.5 kg	60
17020329	✓	pro perforated grating 500/222/20, Ø 6.0 mm, stainless steel ¹⁾	C 250	6.7 kg	28
17020104	✓	pro ductile iron elongated bar grating 500/222/20, MW 29/13	D 400	7.7 kg	98
17020105	✓	pro ductile iron slotted grating 500/222/20, SW 14/200	E 600	8.9 kg	98
17020183	✓	pro ductile iron design grating "KIARO" 500/222/20, SW 7 ^{1) 3)}	D 400	7.9 kg	70
17020184	✓	pro ductile iron design grating "VIA" 500/222/20, SW 6 ^{1) 3)}	D 400	8.2 kg	70
17020180	✓	pro ductile iron design grating "VILLE" 500/222/20, SW 7 ¹⁾	E 600	10.8 kg	70
32089		pro anti-vandalism locking device Requirement: 2 pieces per cover	stainless steel	0.1 kg	
Item no.		Gratings 4 point boltable (only in cast iron edge)	Load class	Weight	Pcs./Pallet
17020103	✓	pro ductile iron elongated bar grating 500/222/20, MW 22/13 ⁴⁾	E 600	9.5 kg	98
17020107	✓	pro ductile iron slotted grating NW 200, 500/222/20, SW 14/95 ⁴⁾	F 900	12.3 kg	70
17020113	✓	pro ductile iron cover, closed, 500/222/20 ¹⁾	E 600	11.2 kg	70
32103		pro locking device kit for ductile iron grating class D and E (1 pc. bolt, 1 pc. nut - 8 pcs. required per m)			
32109		pro locking device kit stainless steel for ductile iron grating class D and E (1 pc. bolt, 1 pc. nut - 8 pcs. required per m)			
Item no.	Accessories		Material	Weight	Pcs./Pallet
10620192	pro sump unit G 500/265/750 incl. pipe coupling Ø 200 and plastic sediment bucket		FILCOTEN® HPC	49.1 kg	6
10620292	pro sump unit V 500/265/750 incl. pipe coupling Ø 200 and plastic silt bucket		FILCOTEN® HPC	48.7 kg	6
10620392	pro sump unit E 500/265/750 incl. pipe coupling Ø 200 and plastic silt bucket ¹⁾		FILCOTEN® HPC	48.7 kg	6
19020215	pro front cap (no. 20-0)		galvanized steel	0.9 kg	
19020216	pro end cap with outlet Ø 200 (no. 20-0)		galvanized steel	1.2 kg	
19015200	pro mini front cap (H = 100 und H = 120 mm)		galvanized steel	0.3 kg	
19020295	pro step displace plate NW 200, Nr. 0-20/0		galvanized steel	0.2 kg	
19020902	pro rebar support NW 150-200		galvanized steel	0.8 kg	
19021208	pro no hub bottom outlet 8" (200 mm)		galvanized steel	1.0 kg	
70154	pro pipe Connector DN 200, L = 295 mm (PVC-U)		PVC	1.1 kg	

NEW

 Complies with ASME: A112.6.8 Heel-Resistant Grates

 Complies with ADA - American Disabilities Act



BG-FILCOTEN[®]

pro



Mesh grating MW 30/10 class C, galvanized steel & stainless steel for NW 100 to 200



Mesh grating MW 25/10, class D NW 100 – galvanized steel & stainless steel, NW 150 and 200 – galvanized steel



Slotted grating SW 8/80, class C, galvanized steel & stainless steel, for NW 100



Perforated grating, Ø 6,0 mm, class C galvanized steel & stainless steel for NW 100 to 200



Ductile iron slotted grating SW 14/100, 14/150, 14/200 for NW 100 to 200 class E, with fiX-locking for NW 100 to 200 Class D 4 point boltable



COMBee design grating Ø 7,3 mm, class B plastic PA6 for NW 100



COMTread design grating SW 8/40, class C plastic PA6 for NW 100



Ductile iron cover, closed for NW 100 to 200 4-point boltable



Ductile iron elongated bar grating MW 29/6 class C, narrow SW for NW 100



Ductile iron elongated bar grating MW 29/13, class C or class D for NW 100 to 200



Ductile iron elongated bar grating MW 28/9, class D for NW 100 and 150



Ductile iron elongated bar grating MW 29/13 – NW 100 & 150 MW 25/13 – NW 150 up to class D MW 22/13 – NW 150 & 200, up to class E 4 point bolted only available in cast iron edge



Ductile iron design grating KIARO, class D, SW 7 for NW 100 to 200



Ductile iron design grating VIA, class D, SW 6-7 for NW 100 to 200



Ductile iron design grating VILLE, class E, SW 7 for NW 100 to 200



Slot top 2S, SW 2x6 mm C, NW 100, V & E



Ductile iron slotted grating SW 14/100, 14/150, 14/200 for NW 100 to 200 class F, 4 point bolted

References

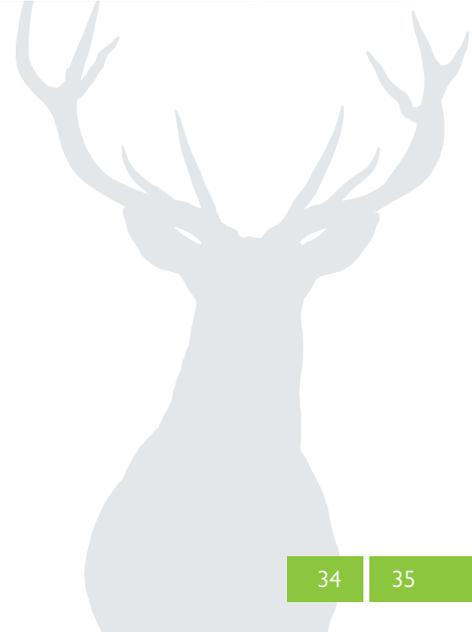

up to class F 900

BG-FILCOTEN[®]

pro

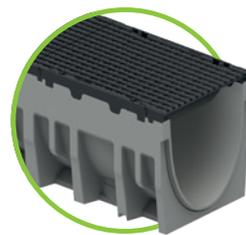

BG-FILCOTEN[®] pro incl. edges, NW 300 mm / 12"

Drainage channel made of FILCOTEN[®] HPC (High Performance Concrete) with integrated cast iron (G) or galvanized steel edge (V), up to class F

Item no.	Channel body with galvanized steel edge and safety joint	Slope	Weight	Pcs./Pallet
10630200	pro V NW 300, no. 0	0.0 %	78.0 kg	6
10630261	pro V NW 300, no. 5-0	0.0 %	84.5 kg	6
10630262	pro V NW 300, no. 10-0	0.0 %	88.6 kg	6
10630264	pro V NW 300, no. 20-0	0.0 %	109.0 kg	6
10630201-10	pro V NW 300, no. 1 to no. 10	0.5 %	78.5 – 88.0 kg	6
10630211-20	pro V NW 300, no. 11 to no. 20	0.5 %	89.6-107.4 kg	6
Item no.	Channel body with ductile iron edge and safety joint	Slope	Weight	Pcs./Pallet
10630100	pro G NW 300, no. 0	0.0 %	81 kg	6
10630161	pro G NW 300, no. 5-0	0.0 %	86.5 kg	6
10630162	pro G NW 300, no. 10-0	0.0 %	92.5 kg	6
10630164	pro G NW 300, no. 20-0	0.0 %	110.7 kg	6
10630101-10	pro G NW 300, no. 1 to no. 10	0.5 %	81.5 - 91.0 kg	6
10630111-20	pro G NW 300, no. 11 to no. 20	100.5 %	56.3-110.7kg	6

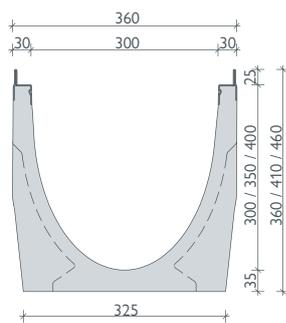

Galvanized steel edge

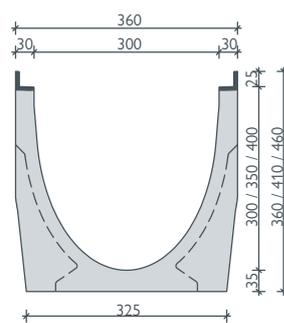

Ductile iron edge



BG-FILCOTEN[®] pro mini incl. edges, NW 300 mm / 12"

Drainage channel made of FILCOTEN[®] HPC (High Performance Concrete) with integrated cast iron (G) or galvanized steel edge (V), up to class F – very low construction height

Item no.	Channel body with galvanized steel edge and safety joint	Slope	Weight	Pcs./Pallet
10530200	pro V mini NW 300, H = 120 mm	0.0 %	36.2 kg	12

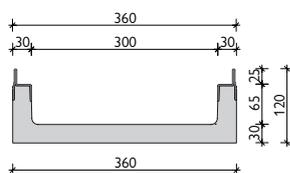

galvanized steel edge
BH 120 mm



Gratings and accessories

for BG-FILCOTEN® pro and pro mini with cast iron (G) or galvanized steel edge (V), NW 300 mm / 12"

Item no.		Gratings with fiX-locking – 4 point bolttable	Load class	Weight	Pcs./Pallet
17030222	✓	per mesh grating 1000/347/25, MW 30/10 ^{2) 3)}	C 250	23.1 kg	24
17030223	✓	per mesh grating 500/347/25, MW 30/10 ^{2) 3)}	C 250	11.6 kg	24
17030103	✓	pro ductile iron elongated bar grating 500/347/25, MW 29/13 ²⁾	E 600	17.9 kg	28
17030107		pro ductile iron slotted grating 500/347/20, SW 14/95	F 900	22.3 kg	30
17030183	✓	pro ductile iron design grating "KIARO" 500/347/25, SW 7 ^{2) 3)}	D 400	19.3 kg	28
17030184	✓	pro ductile iron design grating "VIA" 500/347/25, SW 6 ^{2) 3)}	D 400	17.5 kg	28
17030180	✓	pro ductile iron design grating "VILLE" 500/347/25, SW 8 ^{2) 3)}	E 600	20.0 kg	28
17030109	✓	pro ductile iron cover, closed, 500/347/25	F 900	25.4 kg	28
32112		pro locking device kit for mesh grating class C (1 pc. bolt, 1 pc. nut – 4 pcs. required per m)			
32110		pro locking device kit for ductile iron grating class D and E (1 pc. bolt, 1 pc. nut – 8 pcs. required per m)			
32122		pro Bolting material , stainless steel, for ductile iron grating class D and E (1 pc. bolt, 1 pc. nut – 8 pcs. required per m)			
Item no.		Accessories	Material	Weight	Pcs./Pallet
10630192		pro sump unit 560/520/950 incl. pipe coupling Ø 200 and sediment bucket made of galvanized steel	FILCOTEN® HPC	127.0 kg	2
10630292		pro sump unit V 560/520/950, 2-part, incl. pipe coupling Ø 200 and sediment bucket made of galvanized steel	FILCOTEN® HPC	126.2 kg	2
19060020		pro sump unit middle part, 560/500/415	FILCOTEN® HPC	42.5 kg	4
19021208		pro no hub bottom outlet 8"	galvanized steel	1.0 kg	
19030213		pro front cap (no. 0 – 20-0)	galvanized steel	1.7 kg	
19030214		pro end cap with outlet Ø 200 (no. 0 – 20-0)	galvanized steel	1.6 kg	
19030210		pro mini front cap (H = 120 mm)	galvanized steel	0.5 kg	
19030290		pro adaptor plate NW 300, to connect pro NW 100, NW 200	galvanized steel	1.7 kg	
19030295		pro step displace plate NVV 300, Nr. 0-20/0	galvanized steel	0.4 kg	
19030902		pro rebar support NW 300	galvanized steel	1.1 kg	

NEW

 Complies with ASME: A112.6.8 Heel-Resistant Grates

 Complies with ADA - American Disabilities Act



With NW 300, gratings can also be bolted onto the galvanized steel edge.

Gratings: BG-FILCOTEN® pro and pro mini NW 300 mm / 12"



Mesh grating MW 30/10 class C, galvanized steel 4-point bolttable



ductile iron elongated bar grating MW 29/13, class D or class E 4-point bolttable



ductile iron slotted grating SW 16/140, class F 900 4-points bolttable



Ductile iron cover closed, class F 4 point bolttable



ductile iron design grating VIA, class D, SW 6 4-point bolttable



ductile iron design grating VILLE, class E, SW 8 4-point bolttable



ductile iron design grating KIARO, class D, SW 7 4-point bolttable

up to class E 600

BG-FILCOTEN[®] pro



BG-FILCOTEN[®] pro incl. cast iron edge, NW 400 mm / 16"

Drainage channel made of FILCOTEN[®] HPC (High Performance Concrete) with integrated cast iron edge (G) up to class E

Item no.	Channel body with ductile iron edge and safety joint	Slope	Weight	Pcs./Pallet
10641100	pro G NW 400, no. 0, L = 1000 mm	0.0 %	146.0 kg	4



On demand.

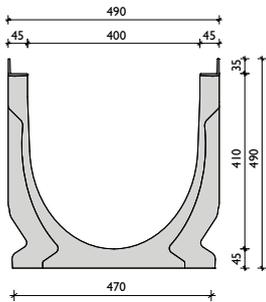

Ductile iron edge

Gratings and accessories

for BG-FILCOTEN[®] pro with cast iron edge (G), NW 400 mm / 16"



ductile iron slotted grating
SW 18/215, class E
4-point boltable

Item no.	Gratings 4 point bolted	Load class	Weight	Pcs./Pallet
17040181	pro ductile iron slotted grating 500/474/35, SW 18/215 ¹⁾	E 600	34.5 kg	20
32110	pro Bolting material for ductile iron slotted grating (1 pc. bolt, 1 pc. nut – 8 pcs. required per m)			
32122	pro Bolting material stainless steel for ductile iron slotted grating (1 pc. bolt, 1 pc. nut – 8 pcs. required per m)			
Item no.	Accessories	Material	Weight	Pcs./Pallet
10640192	pro sump unit G 560/520/1130 incl. pipe coupling Ø 200 and sediment bucket made of galvanized steel	FILCOTEN [®] HPC	178.8 kg	2
10640193	pro sump unit G 560/540/1230 incl. pipe coupling Ø 300 and sediment bucket made of galvanized steel	FILCOTEN [®] HPC	226.6 kg	2
19040213	pro front cap	galvanized steel	4.5 kg	
19040214	pro end cap with outlet Ø 200	galvanized steel	4.7 kg	
19040215	pro end cap with outlet Ø 300	galvanized steel	4.4 kg	
70154	pro pipe connector DN 200, L = 295 mm	(PVC-U) PVC	1.1 kg	



On demand.



References



up to class F 900

BG-FILCOTEN® connect



BG-FILCOTEN® connect with cast iron edge, NW 100

Drainage channel made of FILCOTEN® HPC (High Performance Concrete) with integrated cast iron edge (G) up to class F

Item no.	Channel body with ductile iron edge and safety joint	Slope	Weight	Pcs./Pallet
10610162	connect, NW 100, no. 10-0	without slope	26.1 kg	20
Item no.	Gratings 4 point bolted	Load class	Weight	Pcs./Pallet
17010113	Ductile iron cover, 500/122/20, closed cover ¹⁾	E 600	5.3 kg	168
32103	Bolting material for ductile iron gratings, galvanized steel (1 pc. bolt, 1 pc. nut – requirement per m 8 pcs.)			
32109	Bolting material for ductile iron gratings (1 pc. bolt, 1 pc. nut – requirement per m: 8 pcs.)			
Item no.	Accessories	Material	Weight	Pcs./Pallet
19010410	connect cable support NW 100, 1000/64/15, MW 31/31	plastic	0.5 kg	
19010400	connect front cap	galvanized steel	0.3 kg	

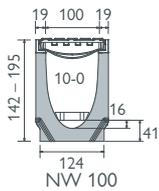

NW 100

BG-FILCOTEN® connect with cast iron edge, NW 150

Drainage channel made of FILCOTEN® HPC (High Performance Concrete) with integrated cast iron edge (G) up to class F

Item no.	Channel body with ductile iron edge and safety joint	Slope	Weight	Pcs./Pallet
10615162	connect, NW 150, no. 10-0	without slope	40.0 kg	12
Item no.	Gratings 4 point bolted	Load class	Weight	Pcs./Pallet
17015113	Ductile iron cover, 500/172/20, closed cover ¹⁾	E 600	7.9 kg	96
32103	Bolting material for ductile iron gratings, galvanized steel (1 pc. bolt, 1 pc. nut – requirement per m 8 pcs.)			
32109	Bolting material for ductile iron gratings (1 pc. bolt, 1 pc. nut – requirement per m: 8 pcs.)			
Item no.	Accessories	Material	Weight	Pcs./Pallet
19015410	connect cable support, 1000/108/25, MW 31/31	plastic	1.2 kg	
19015215	connect front cap	galvanized steel	0.5 kg	

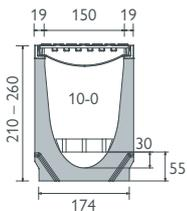

NW 150

BG-FILCOTEN® connect with cast iron edge, NW 200

Drainage channel made of FILCOTEN® HPC (High Performance Concrete) with integrated cast iron edge (G) up to class F

Item no.	Channel body with ductile iron edge and safety joint	Slope	Weight	Pcs./Pallet
10620162	connect, NW 200, no. 10-0	without slope	55.3 kg	6
Item no.	Gratings 4 point bolted	Load class	Weight	Pcs./Pallet
17020113	Ductile iron cover, 500/222/20, closed cover ¹⁾	E 600	11.2 kg	70
32103	Bolting material for ductile iron gratings, galvanized steel (1 pc. bolt, 1 pc. nut – requirement per m 8 pcs.)			
32109	Bolting material for ductile iron gratings (1 pc. bolt, 1 pc. nut – requirement per m: 8 pcs.)			
Item no.	Accessories	Material	Weight	Pcs./Pallet
19020410	connect cable support, 1000/142/25, MW 31/31	plastic	1.7 kg	
19020215	connect front cap	galvanized steel	0.8 kg	

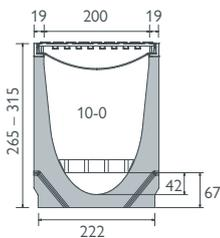

NW 200

BG-FILCOTEN® connect with cast iron edge, NW 300

Drainage channel made of FILCOTEN® HPC (High Performance Concrete) with integrated cast iron edge (G) up to class F

Item no.	Channel body with ductile iron edge and safety joint	Slope	Weight	Pcs./Pallet
10630162	connect, NW 300, no. 10-0	without slope	92.5 kg	6
Item no.	Gratings 4 point bolted	Load class	Weight	Pcs./Pallet
17030109	Ductile iron cover, 500/347/25, closed cover ¹⁾	F 900	25.4 kg	30
32110	Bolting material for ductile iron gratings, galvanized steel (1 pc. bolt, 1 pc. nut – requirement per m 8 pcs.)			
Item no.	Accessories	Material	Weight	Pcs./Pallet
19030410	connect cable support, 1000/201/25, MW 31/31	plastic	2.3 kg	
19020213	connect front cap	galvanized steel	1.7 kg	

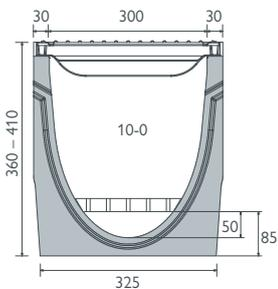

NW 300



Tangled cables? Not with us ...

Sturdy, maintenance-free, efficient:

BG-FILCOTEN[®] connect

BG-FILCOTEN[®] connect makes laying cable bundles so much simpler. Because this innovative media duct is not only sturdy and lightweight – making it easy to install – its intelligent design means that it is also extremely easy to service and maintain. Giving you the flexibility you need every time.

Closed cover

- Class E 600 kN
- with anti-slip surface
- suitable for fork-lift trucks

Grating lock

- Integrated fix-locking for quick and easy removal of the grating
- Bolt connections optionally available (8 per metre) where the load strain and safety demands are higher

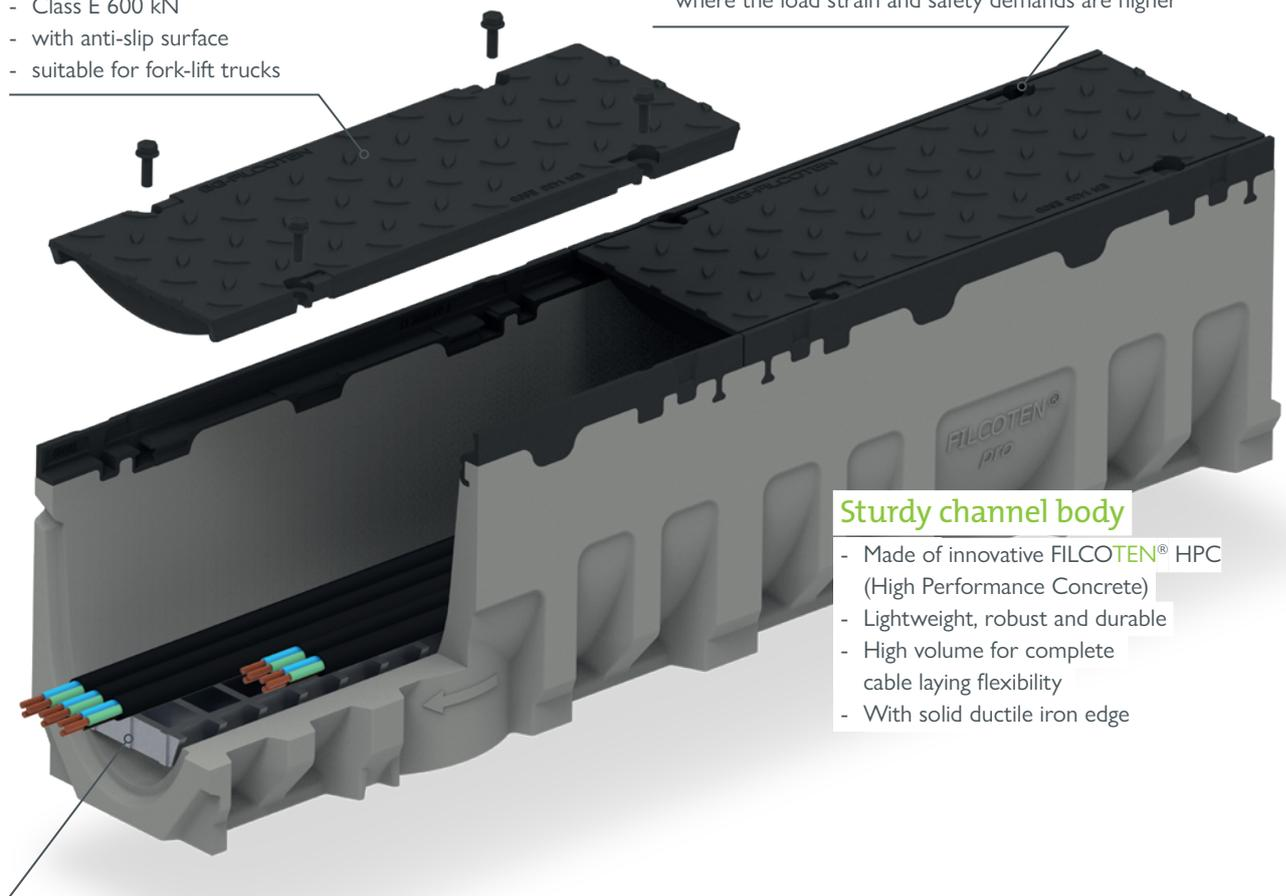

Sturdy channel body

- Made of innovative FILCOTEN[®] HPC (High Performance Concrete)
- Lightweight, robust and durable
- High volume for complete cable laying flexibility
- With solid ductile iron edge

Functional cable support

- Provides dry support for cables used outdoors should rain ever seep into the system
- Electrically non-conductive due to plastic construction

Your benefits at a glance:

- Sturdy, lightweight and durable thanks to the FILCOTEN[®] HPC
- Bolt-mounted grating; nuts and bolts replaceable
- Non-conductive due to use of GFR²⁾ in the cable support
- Ideal for exhibition and event halls as well as for factory premises and production plants

²⁾ GFR: Glass fibre reinforced plastic

We set the Water a new **purity standard.**

The new BG-FILCOTEN® green features an innovative filter system, enabling superior cleaning performance. At the same time, the system is easy to install and maintain.

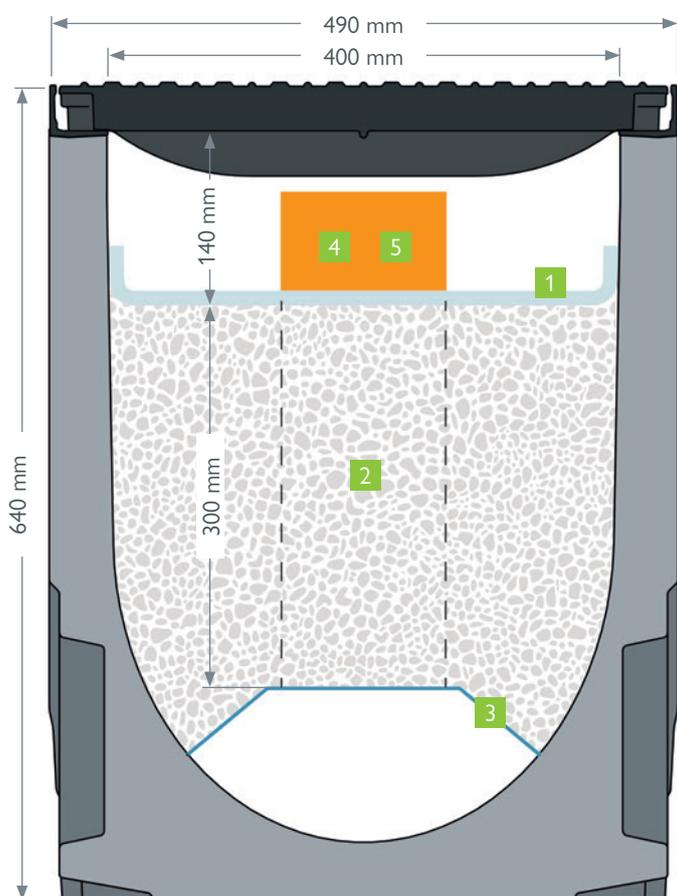

1 Pre-filter fleece for efficient preclearing.

- The pre-filter non-woven material keeps out coarse dirt, protecting the high-quality technical filter material
- Very easy to install, maintain and replace

2 Innovative cleaning filter material.

- Filter material in optimised quantity (height: 300 mm)
- Highest possible cleaning class
- Homogeneous material, no separation during use
- No risk of remobilising heavy metals due to water containing de-icing salts

3 Trapezoid-shaped perforated sheet metal made from stainless steel.

- Separates the filter substrate zone from the drainage area, keeping the transverse drainage section permanently clear
- Optimised perforated surface for maximum drain of water

4 Integrated Control & water sampling shaft.

- Control/water abstraction shaft for visual control and sampling
- Easiest handling: Remove the grating and take the water sample
- The purified water can then be taken and tested for its ingredients

5 Innovative overflow Ø 150 for efficient heavy rain drainage.

- Effective protection even in most extreme rainfall
- Cleaning of polluted first flush via the technical filter
- Unpolluted excess water can drain out through the overflow pipe in a controlled way
- ATTENTION! Approval of the authority must be given for this device.



BG-FILCOTEN® green

BG-FILCOTEN® green incl. cast iron edge, NW 400

Drainage channel made of FILCOTEN® HPC (High Performance Concrete) with integrated cast iron (G) up to class E

Item no.	Channel body with ductile iron edge and safety joint	Slope	Weight	Pcs./Pallet
10641166	green G NW 400, no. 30-0, H 640, L= 1000 mm	0.0 %	179.0 kg	1
10641176	green G NW 401, no. 30-0, H 640, with outlet opening Ø 200, L = 1000 mm	0.0 %	176.0 kg	1



Gratings

for BG-FILCOTEN® green with ductile iron edge (G), NW 400

Item no.	Gratings 4 point boltable	Load class	Weight	Pcs./Pallet
17040181	green ductile iron slotted grating 500/474/35, SW 18/215 ¹⁾	E 600	34.5 kg	20
32110	green locking device kit for ductile iron slotted grating (1 pc. bolt, 1 pc. nut - 8 pcs. required per m)			
32122	green locking device kit stainless steel for ductile iron slotted grating (1 pc. bolt, 1 pc. nut - 8 pcs. required per m)			



ductile iron slotted grating
SW 18/215, class E
4-point boltable

Accessories

Installation parts for filter unit, front-/end caps

Item no.	Accessories	Material	Weight
19540910	green pre-filter mat, L = 5000 mm, B = 500 mm		0.9 kg
19040361	green trapezoid perforated sheet metal, L = 1000 mm	stainless steel	2.5 kg
19540956	Set – water sampling shaft consisting of: trapezoid perforated sheet metal with outlet Ø 150, L = 2000 mm, Pipe plug, bolting material	Stainless steel/ PVC	6.6 kg
19040353	green partition sheet	stainless steel	1.9 kg
19040350	green front cap	stainless steel	4.7 kg
19040351	green end cap with Ø 150 outlet	stainless steel	5.6 kg
19040500	green tool for substrate flattening	wood	1.2 kg



The substrate filter material shall be supplied by third parties in accordance with local filtration regulations.



Technical data CA: www.say.bg/31/green
Technical data USA: www.say.bg/12/green

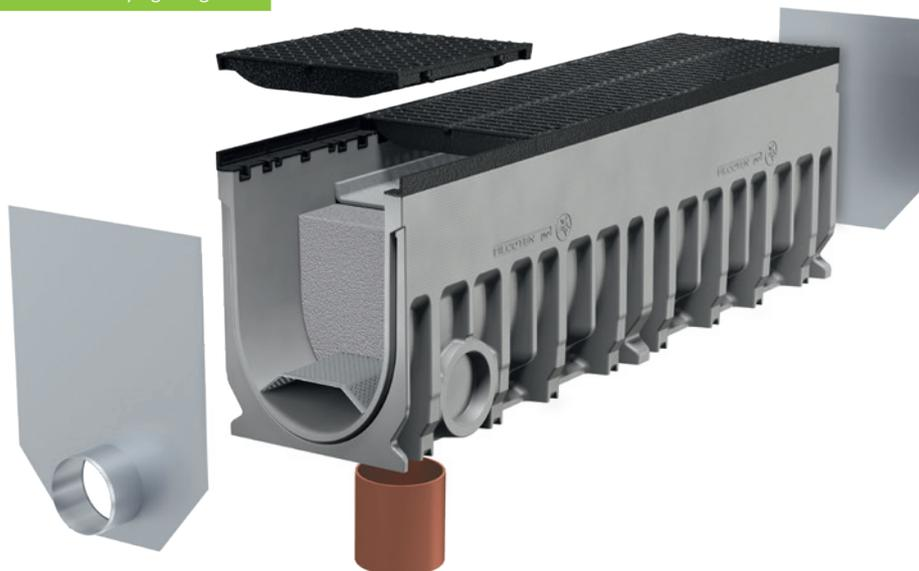

BG-FILCOTEN®

Sump units incl. silt bucket

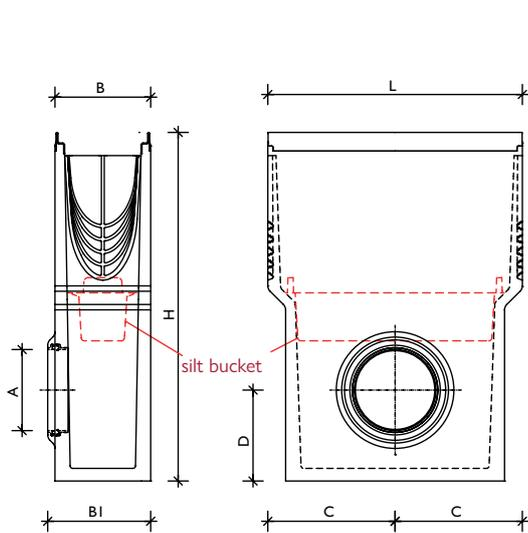

BG-FILCOTEN® sump unit, one part
incl. silt bucket made of plastic

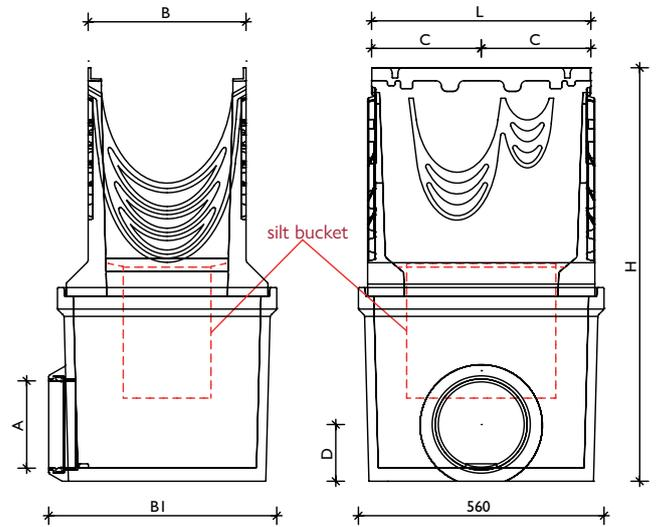

BG-FILCOTEN® pro 300/400 sump unit, two parts
incl. galvanized steel sediment bucket

family	NW	Set item no. / one part	L	B	B 1	H	C	D	Outlet A
BG-FILCOTEN® self	100	10710290	500	122	138	380	250	125	Pipe coupling DN 100
BG-FILCOTEN® light	150	10315092	500	180	195	650	250	190	Pipe coupling DN 150
BG-FILCOTEN® tec	100	10410294 [∇] / 10410394 [Ⓔ]	500	130	144	500	250	130	Pipe coupling DN 150
BG-FILCOTEN® pro	100	10610192 [Ⓔ]	500	138	145	600	250	130	Pipe coupling DN 100
	150	10615292 [∇] / 10615192 [Ⓔ] / 10615392 [Ⓔ]	500	188	200	690	250	180	Pipe coupling DN 150
	200	10620292 [∇] / 10620192 [Ⓔ] / 10620392 [Ⓔ]	500	238	265	750	250	135	Pipe coupling DN 200

family	NW	Set item no. / two parts	L	B	B 1	H	C	D	Outlet A
BG-FILCOTEN® pro	300	10630292 [∇] / 10630192 [Ⓔ]	500	360	520	950	250	130	Pipe coupling DN 200
	400	10640192 [Ⓔ]	500	490	520	1130	250	130	Pipe coupling DN 200
		10640193 [Ⓔ]	500	490	540	1230	250	190	Pipe coupling DN 300

[∇] Sump unit with galvanized steel edge | [Ⓔ] Sump unit with cast iron edge | [Ⓔ] Sump unit with stainless steel edge

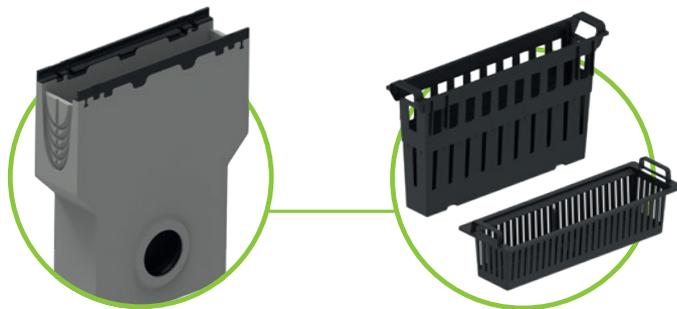

Pipe-coupling system:
A pipe fair lead is already installed in the outlet connector. The sewer pipe connection can be made here directly and quickly.

Sump unit incl. sediment bucket, made of plastic



References

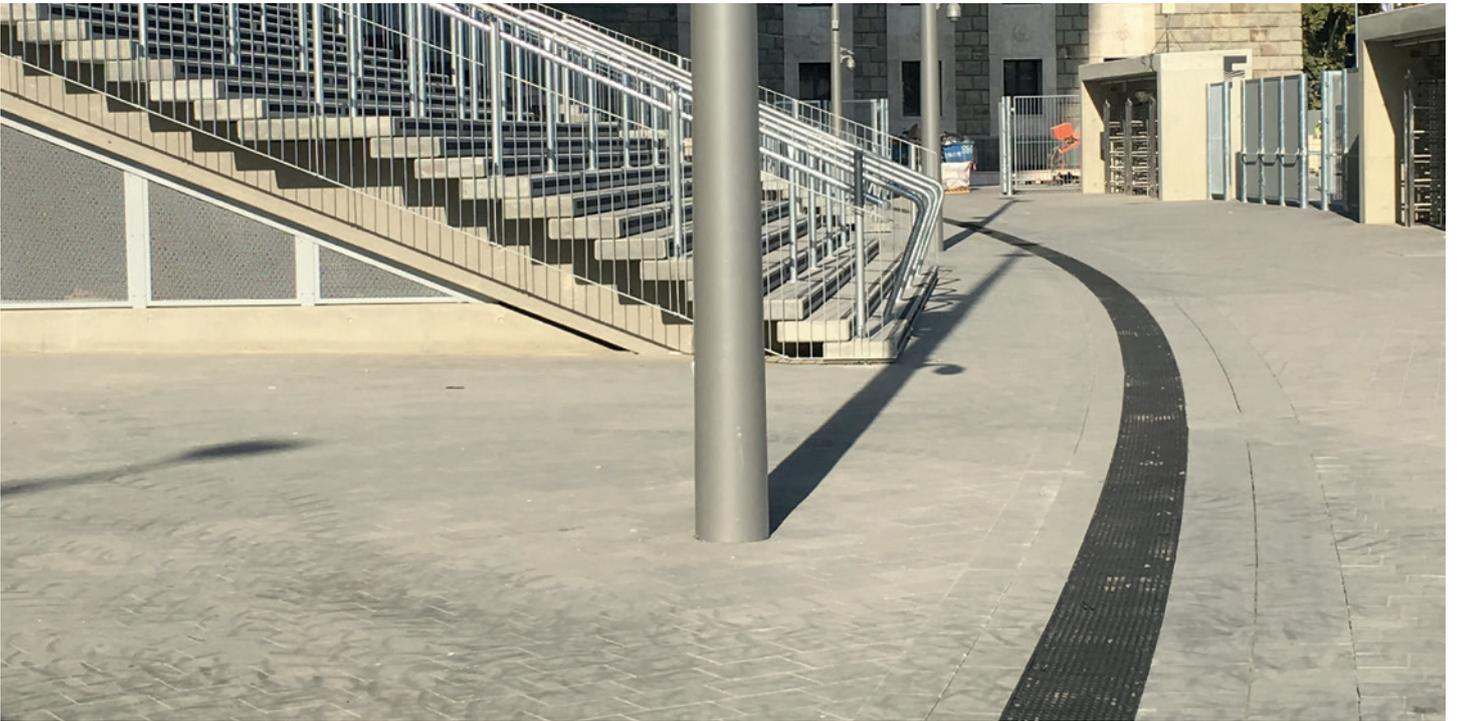

BG-FILCOTEN®

tec / pro



No Hub bottom outlet DN 100 to 200 for NW 100 to 300



Bottom outlet on site installation

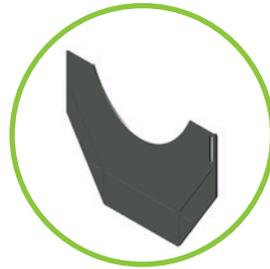

Step connector plate, galvanized, available for NW 100 to NW 300



Positioning of outlet drilling: Channel end to outlet opening centre = 250 mm



a) Front/end cap with outlet

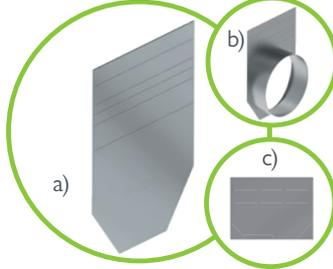

a) Front cap, each NW
b) End cap with outlet, each NW
c) Front cap tec/pro mini, each NW



BG-FILCOTEN® sump units tec/pro, L=500 mm, incl. silt bucket made of plastic, to fit all NW



Anti-vandalism locking device for all gratings with fiX locking for NW 100/150/200 – except slotted gratings and COMBee design gratings (tec / pro).
Required per grating: 2 pieces

i Detailed description on page 45



Bolting kits for pro (to be ordered separately) consisting of:
1 pc. bolt, 1 pc. nut galvanized steel or stainless steel

Suitable for use with gratings: see table per NW
See footnotes!

i M8 for NW 100 – 200 / 10 for NW 300 – 400

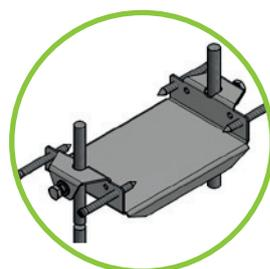

Rebar support, available for NW 100 to NW 300

A connection, that keeps our promises.

The various different fixing options for our gratings meet the requirements of channel standard EN 1433. Furthermore, they also allow you to adapt the safety measures to your own specification. The

fiX-locking ensures a rapid, secure fixing of the grating while the anti-vandalism locking device goes one step further.

More security on request: optional anti-vandalism locking device (for NW 100 mm / 4" , 150 mm / 6" and 200 mm / 8")



Step 1:
Push the locking device into the fitting springs provided for this purpose until it snaps into place.



Step 2:
Attach the grating as described for the fiX-locking below into the BG-FILCOTEN® tec/pro channel.



Step 3:
Push the grating firmly into the channel until it snaps into place.



Step 4:
Lock the anti-vandalism device by twisting the bolt.

Simply secure: the 4 point fiX-locking

The „fiX-locking“ enables a 4 point boltless locking device for the grating in the channel. The fitting springs for each grating variant engage in the recess in the edge provided for this, and the grating is simply and securely mounted.

- The coverings are initially inserted on one side of the channel with an exact fit and are locked by means of a simple turning of the grating.
- When doing this, look out for the recesses in the edge in which the clamps against longitudinal slipping engage.
- The fiX-locking fixes the grating in the edge. This connection can be unfastened by pulling it out.
- The fiX-locking system can be used with ductile iron and mesh gratings.



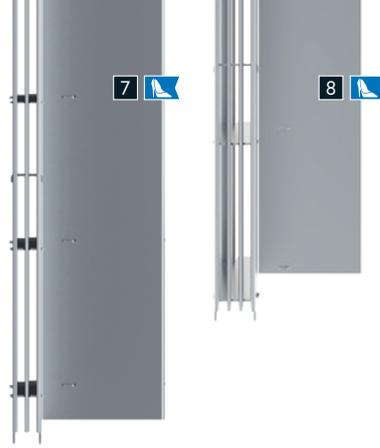
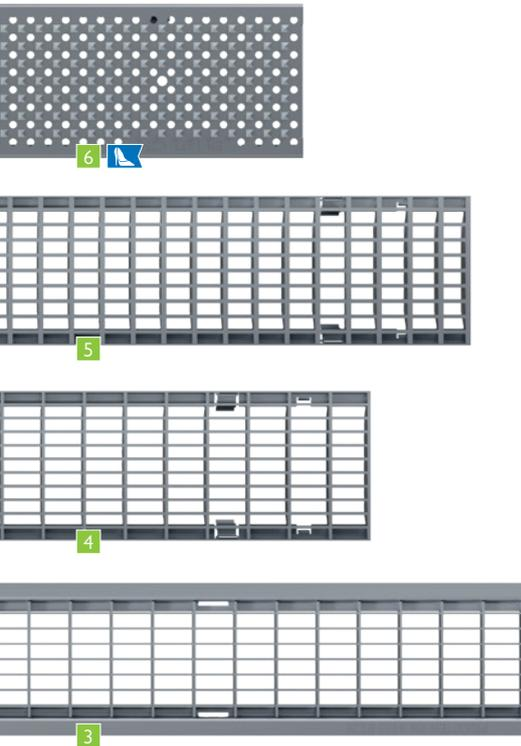

BG-FILCOTEN® self & light

Gratings	SW, MW, Ø in mm	
1 self slotted grating	SW 5/80	
2 light slotted grating	SW 8/130	
3 Mesh grating	MW 30/10	
7 Slot top 2S, Heelproof	SW 2x6	
8 Slot top 3S, Heelproof	SW 3x6	
On demand		
9 light ductile iron mesh grating	MW 15/28	

BG-FILCOTEN® tec & city mini

Gratings	SW, MW, Ø in mm	
2a Slotted grating	SW 8/80	
4 Mesh grating	MW 30/10	
6 Perforated grating	Ø 6.0	
7 Slot top 2S, Heelproof	SW 2x6	
8 Slot top 3S, Heelproof	SW 3x6	
18 COMBee design grating	Ø 7.3	
14 COMTread slotted design grating	SW 8/40	
10 Ductile iron elongated bar gr.	MW 29/13	
11 Ductile iron elongated bar grating, narrow SW	MW 29/6	

The gratings on the left are
beautiful & functional.
 On the right, it's **the other way round.**

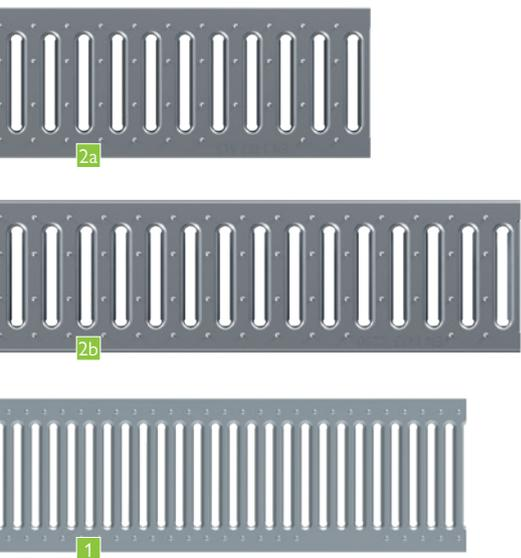

BG-FILCOTEN® pro

Gratings	SW, MW, Ø in mm	
2b Slotted grating	SW 8/80	
4 Mesh grating ³⁾	MW 30/10	
5 Mesh grating	MW 25/10	
6 Perforated grating	Ø 6.0	
18 COMBee design grating	Ø 7.3	
14 COMTread slotted design grating	SW 8/40	
10 Ductile iron elongated bar gr. ^{3) 4)}	MW 29/13	
11 Ductile iron elongated bar grating, narrow SW	MW 29/6	
12 Ductile iron elongated bar grating, 4 point boltable	MW 25/13	
13 Ductile iron elongated bar grating, narrow SW	MW 22/13	
20 Ductile iron slotted grating ^{3) 4)}	MW 28/9	
15 Ductile iron slotted grating ^{3) 4)}	SW 14	
16 Ductile iron design gr. KIARO ³⁾	SW 7	
17 Ductile iron design gr. VIA ³⁾	SW 6-7	
17 Ductile iron design gr. VILLE ³⁾	SW 7-8	
21 Ductile iron cover, closed		
19 Ductile iron slotted grating	SW 14/95	

22 pro / green ductile iron slotted gr.	SW 18/215	
---	-----------	--

²⁾ Material:

V: Galvanized steel | E: Stainless steel
 G: Ductile iron | PA6: Polyamide plastic
 KTL: KTL coated ductile iron

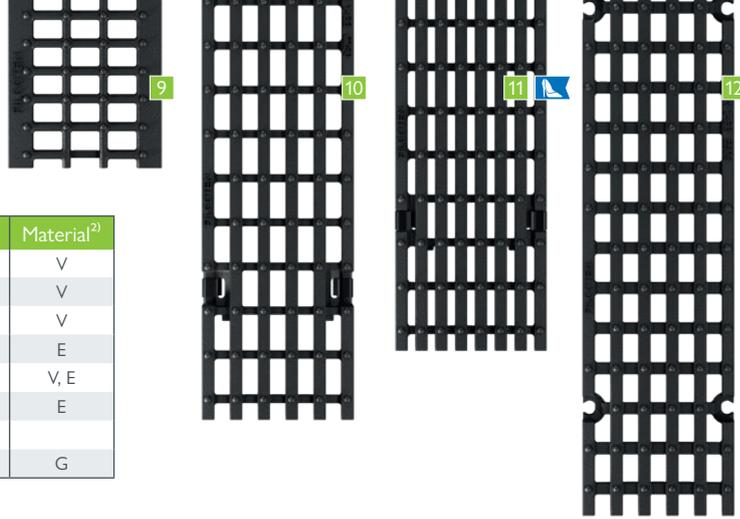

BG-FILCOTEN®

	NW 100	NW 150	NW 200	NW 300	Class ¹⁾	Material ²⁾
	✓				A	V
		✓			A	V
		✓			car accessible	V
	✓				B	E
	✓	✓			C	V, E
	✓	✓			C	E
		✓			C	G

	NW 100	NW 150	NW 200	NW 300	Class ¹⁾	Material ²⁾
	✓				A, C	V, E
	✓				B	V
	✓				C	V, E
	✓				A, C	V, E
	✓				B	E
	✓				C	V, E
	✓				C	E
	✓				B, C	PA6
	✓				C	PA6
	✓				C	G
	✓				C	G

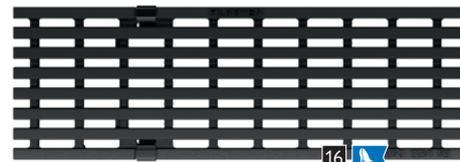
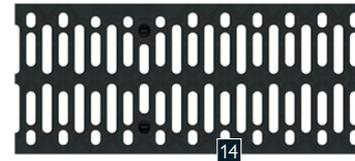
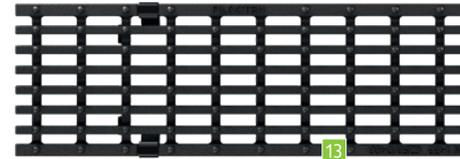

	NW 100	NW 150	NW 200	NW 300	Class ¹⁾	Material ²⁾
	✓				C	V, E
	✓	✓	✓		C	V, E
				✓	C	V
	✓	✓	✓		D	V, E
	✓	✓	✓		C	V, E
	✓				C	PA6
	✓				C	PA6
	✓	✓	✓		C, D	G
				✓	D, E	G
	✓				C	G
		✓			D	G
	✓	✓	✓		E	G
	✓	✓			D	G
	✓	✓	✓		D, E	G
	✓	✓	✓	✓	D	G
	✓	✓	✓	✓	D	G
	✓	✓	✓	✓	E	G
	✓	✓	✓	✓	E	G
				✓	F	G
	✓	✓	✓	✓	F	G



www.say.bg/blacklabel_en.pdf



BG-BLACKLABEL design line

7 8 14 15 16 17 18



¹⁾ classes according to EN 1433:

A 15 kN | B 125 kN | C 250 kN | D 400 kN | E 600 kN | F 900 kN

³⁾ From NW 300 4-point bolttable ⁴⁾ incl. fiX-locking system

Monolithic, versatile, good.



BG-FILCOTEN[®] one urban

The BG-FILCOTEN[®] one family has a new addition. And, just like any other family, the BG-FILCOTEN[®] one urban is a totally novel, new arrival on the market. With manifold innovations and a D 400 load class all rolled into one, it offers up a ton of useful features – making it the perfect all-rounder for urban spaces.

Overview of applications

Roads, inner cities, pedestrian zones, cycle paths, gardening and landscaping, car parks, sports complexes.

Class D 400

Inflow opening in the channel joint

Inlet opening in the joint with standard slot width for ideal water drainage

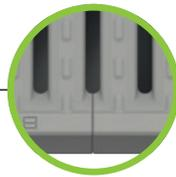

Tenon system for non-directional installation

- Non-directional channel joint for easy and fast installation
- Interlocking tenon system for snug, truly-aligned positioning of elements
- Predefined distance in the joint for optimum function of the insertable sealing profile

Easy-to-handle sealing system¹⁾

- preformed groove on the front/end sides for easy insertion of the sealing profile
- Permanently sealed joints, guided by the tenon system
- Requirements according to EN 1433



High-performance

High, large-capacity channel body for enhanced drainage performance



GRASPOINTNER
Sustainable innovation.

Cyclist- and pedestrian-friendly

- Grippy, anti-skid pimple surface for pedestrian zones
- Optimised slot widths for safe driving and walking: NW 100 = 10 mm, NW 150 = 12 mm, NW 200 = 15 mm
- Slot widths according to EN 1433

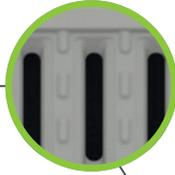

Integrates fully with the surrounding environment

Surface in characteristic concrete colour

Optimised inlet surface

Recessed inflow openings and pimple surface for enhanced water collection performance and winter road services

Monolithic structure

- Element made entirely of FILCOTEN® HPC
- Extremely robust and wear resistant
- ideal for dynamic exposure in road traffic

Verified LCA (life cycle assessment)

- low greenhouse gas emission levels
- Manufactured with 100 % green power
- resource-efficient manufacturing process

Multiple certifications

- 100% recyclable, certified quality class U-A⁴⁾
- Certified organic material that meets the strict testing criteria of the Institute for Biologically Sound Construction Rosenheim (IBR) with regard to heavy metals, VOCs, biocides and radioactivity, styrene-free²⁾
- certified³⁾ in acc. with KIWA BRL 5070



Re-designed; multiple benefits: the trapezoidal shape

- Enhanced anchoring performance in levelling concrete
- Optimised structural safety; can be installed as Type I – with so-called Type I installation, no concrete casings are required
- Wide channel foot for solid positioning of the gutter, even during installation
- Due to its very construction, the required grouting joint automatically materialises when installing in curb stone areas or upright areas
- The upper 90 mm of the channel wall are vertical in order to enable ideal working with pavement covering

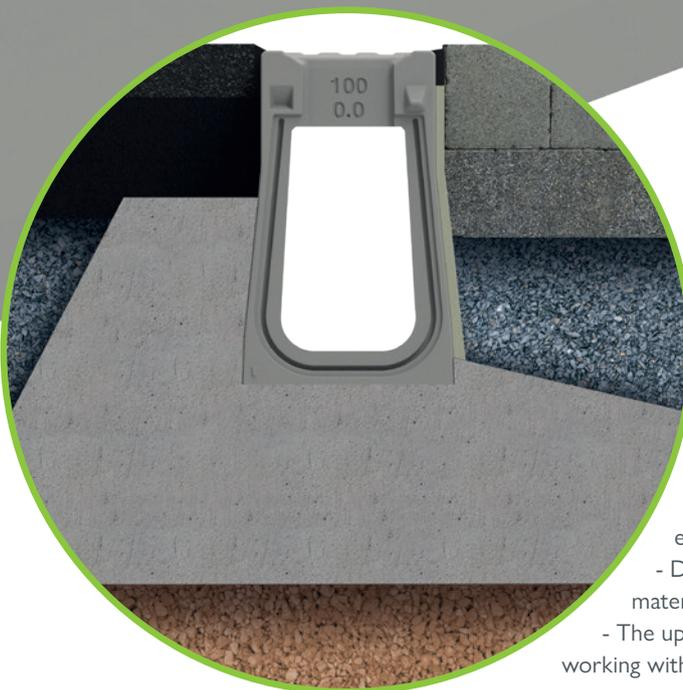

¹⁾ Optional sealing profile.

²⁾ No use of synthetic resins.

³⁾ KIWA certificate number: NL BSB® K43940.

⁴⁾ Quality class U-A (certified by the experimental and research Institute for construction Salzburg)

Well thought-out elements make an outstanding system.

What is a good drainage system all about? Quite simply, it must be more than the sum of its parts. When developing BG-FILCOTEN® one urban, from the start, we always focused on the entire system, not just on the individual single parts.

Class D 400

Intelligent solutions for your requirements

We achieved a great number of intelligent solutions for more efficiency, performance and, above all, easy and safe handling – from the first installation, to the daily use through to the routine maintenance.

One grating – one design

- continuation of the slotted grating design for the cast iron grating
- edge and grating, cathodic dip-coated
- fix-locking as well as 4 point bolted possible
- Class D 400

Sump unit, one part

- Suspended silt bucket for sump unit
- Total length 500 mm
- closed base
- Outlet NW 100 / 150 with DN 150; NW 200 with DN 200 (pipe coupling)
- Left/right rotation
- Maintenance access in the style of the channel run

Outlet element

- Outlet unit NW 100 with DN 100; NW 150 with DN 150 and NW 200 available with DN 200 opening.
- The drainpipe can be serviced/cleaned through the removable grating.

Revision element

- Maintenance access in the style of the channel run
- T-piece with knock-out section (optional)
- Total length 1000 mm
- closed base



Sump unit, upper part

- simple cleaning of the outlet unit
- large outlet opening in the channel bottom
- Suspended silt bucket for sump unit
- T-piece with knock-out section (optional)
- Total length 1000 mm

Front cap

- interlocking
- closure of the channel run

End cap with outlet

- interlocking
- Closure of the run with socket (pipe coupling)
NW 100: DN 100; NW 150: DN 150;
NW 200: DN 200

Basic channel

- NW 100, NW 150 or NW 200
- Standard construction height no. 0
- Total length 1000 mm

sump unit, bottom part

- socket (pipe coupling)
NW 100 / 150: DN 150;
NW 200: DN 200
- left/right rotation

Sustainability in action: FILCOTEN® HPC (High Performance Concrete)

- cement-bound, mineral material
- extremely durable, stable and UV-resistant
- extremely resistant to frost, de-icing salt, oil, gasoline
- 100% recyclable, certified¹⁾
- certified environmental and energy management according to ISO 14001 or 50001 at the location of Oberwang/AT
- tested by the IBR – safe in terms of sustainable building

¹⁾ according to the guidelines of the Austrian Construction Material Recycling Association. ²⁾ Institute of Baubiologie Rosenheim.



BG-FILCOTEN® one urban, NW 100

Monolithic channel made of FILCOTEN® HPC (High Performance Concrete) Class D 400

Item no.	Monolithic channel body D 400 – no slope	Class acc. to EN 1433	Weight	Pcs./Pallet	Euro/pc.
15110100	one urban NW 100 no. 0, Type I, L = 1000 mm, SW 10/70 mm	D 400	43.0 kg	15 pcs.	

BG-FILCOTEN® one urban, NW 100: Inlet cross-section 195 cm²/m | Discharge cross-section 155 cm²/m

Accessories

for BG-FILCOTEN® one urban, NW 100

Item no.	Accessories	Class acc. to EN 1433	Weight	Euro/pc.
15110000	Corner element, variable, NW 100	D 400	36.3 kg	
15110180	Maintenance unit NW 100, no. 0, L = 1000 mm incl. ductile iron grating ¹⁾	D 400	41.2 kg	
15110190	Outlet element NW 101 no. 0, L = 1000 mm incl. ductile iron grating, with DN 100 drill hole ¹⁾	D 400	40.8 kg	
15110170	Sump unit, one-piece, NW 100 no. 0, L = 500 mm incl. ductile iron grating, silt bucket, DN 150 outlet ¹⁾	D 400	43.8 kg	
15110175	Sump unit upper section NW 101, no. 0, L = 1000 mm incl. ductile iron grating ¹⁾	D 400	39.2 kg	
19110095	Sump unit bottom section, NW 101, DN 150 outlet		30.0 kg	
19110100	Front cap, NW 100, no. 0, without outlet		1.8 kg	
19110110	End cap NW 100, no. 0, with DN 100 outlet		1.4 kg	
19110900	Lifting hook (consisting of 2 pcs.) NW 100, painted blue		0.4 kg	
19000707	Sealing profile one urban, NW 100		0.1 kg	
32103	pro bolting material for ductile iron gratings class D (1 pc. bolt, 1 pc. nut – 4 pcs. required per m)			
32109	pro bolting material stainless steel, for ductile iron grating class D (1 pc. bolt, 1 pc. nut – 4 pcs. required per m)			

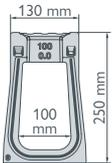

Maintenance unit or outlet element incl. ductile iron grating



Sump unit upper and lower sections DN 150



Sump unit, one-piece, incl. ductile iron grating, silt bucket, outlet DN 150



Corner element, variable



Lifting hook, painted blue for NW 100, 2 pcs. per set



Is a joint sealing profile required? Please say so with your order.



End cap with outlet



Front cap closed

References



Singularly **one,** simply **strong.**

Extraordinary challenges demand superior solutions. Needless to say, this also applies to draining heavily-loaded infrastructures, such as factory premises, logistics centres, terminals or airports. This is where the BG-FILCOTEN® one comes into play – and immediately takes the top spot. Because its channel and grating are cast in one piece, and constructed using the most innovative material on the market: FILCOTEN® HPC (High Performance Concrete).



Absolutely world class – from E 600 to F 900.

The result is an exceptionally sturdy and robust heavy-duty channel for load classes E 600 & F 900 that delivers on high drainage performance. Whether trucks, semi-trailers or aeroplanes: all of them need reliably drained surfaces to travel over – all of them need the new BG-FILCOTEN® one.

Your benefits at a glance:

- Outstanding performance in load classes E 600 & F 900.
- Exceptionally sturdy and durable thanks to the FILCOTEN® HPC monolithic structure.
- Innovative design with intelligent features; sits snugly in the concrete bed.
- Simple to install; easy-to-handle sealing system.
- Sustainable, 100 % recyclable, made using 100 % green energy.

Inflow opening in the channel joint



Inflow opening in the joint with standard slot width for ideal water drainage

Tongue/groove/tenon system for installation in either direction

- Non-directional channel joint for easy and fast installation
- Interlocking of the groove/tongue/tenon system for accurate, aligned setting of the elements
- Predefined distance in the joint for optimum function of the insertable sealing profile

Highly efficient water run

- Channel cross-section with innovative corrugated W-profile design for optimum hydraulic performance on partial and complete filling
- High self-cleaning effect of the W-profile as this causes turbulence in the inflowing water

Easy-to-handle sealing system ⁵⁾

- Preformed groove on the front sides for easy insertion of the sealing profile
- Permanent joint sealing through tight fit of the groove/tongue/tenon system
- Requirements according to EN 1433



Class E 600 & F 900

Optimized inflow openings

- Slot widths according to EN 1433
- Innovative S-design for efficient rainwater inflow

Cyclist- and pedestrian-friendly

- Counter-rotating radial arrangement of the inlet openings
- Safe to drive and walk over thanks to the S-design of the double slots

Monolithic structure

- Element made entirely of FILCOTEN® HPC
- Extremely robust and wear resistant
- Ideal for dynamic exposure in road traffic

Verified LCA ³⁾ (Life Cycle Assessment)

- Greater ecological transparency
- Manufactured with 100 % green power
- Resource-efficient manufacturing process



www.say.bg/en/one_pdf



At one with the surrounding environment

Fine finished concrete structure and surface.

Extremely durable hold in the concrete bed

- Lateral anchoring pockets for maximum anchorage in the concrete bed
- Permanent fit in the foundation thanks to identical linear expansion coefficient
- Perfect connection between HPC and concrete

Areas of use: one for many.

BG-FILCOTEN® one is the first choice wherever heavy dynamic loads may occur. The reason is obvious: Thanks to its monolithic structure and the sophisticated design, it combines an unprecedented number of benefits in one channel system.

Overview of applications:

- airports
- harbours
- terminals
- highways
- industrial areas
- logistic centres
- railway crossings
- truck parking spaces

¹⁾ Meets the strict criteria of the Rosenheim Institute for Building Biology (IBR).
²⁾ Quality class U-A (certified by the Bautechnische Versuchs- und Forschungsanstalt Salzburg (bvfs)).
³⁾ In line with ISO14040, ISO14044, EN15804. ⁴⁾ No use of synthetic resins ⁵⁾ Sealing profile on request.

Perfectly matched for everything that comes along.

What is a good drainage system all about? Quite simply, it must be more than the sum of its parts. This is especially true for heavy-duty applications where, literally, particularly weighty challenges need to be overcome for all components. With this in mind, we focused on creating an entire, robust and high-performance system when developing the BG-FILCOTEN® one.

Intelligent solutions for particularly weighty challenges.

The result is numerous, intelligent solutions that deliver on greater efficiency, robustness and durability and, above all easy and safe handling. Starting with the initial installation and continuing in their daily use and routine maintenance operations.

Class E 600 & F 900

One grating – one design

- Consistent continuation of the S-design, including on cast iron grating
- Edge and grating, cathodic dip-coated
- 4-point bolting
- Class F 900

Basic channel

- NW 200 or NW 150
- Standard construction height no 0
- Total length 1.000 mm

Outlet unit

- Outlet unit NW 150 with DN 150 and/or NW 200 available with DN 200 opening.
- Drainpipe can be serviced/cleaned through the removable grating.

Maintenance unit

- Maintenance access in the style of the channel run
- Total length 1.000 mm
- Closed base



Front cap

- With tongue/groove/tenon system
- Closure of the channel run

End cap with outlet

- With tongue/groove/tenon system
- Closure of channel with socket pipe connection NW 150: DN 150 and NW 200: DN 200 (pipe coupling)

Easy access

- Simple cleaning of the outlet unit
- Large outlet opening in the channel bottom
- Suspended sediment bucket for sump unit
- Total length 1.000 mm

Adapter cap

- For stepped slope installation
- From height no 0 to 40-0

Retention & stepped slope

- Height 40-0 (20 cm higher than no. 0)
- For higher hydraulic requirements
- Longer channel runs possible up to one outlet point
- Suitable for retention (additional volume: NW 150 – 30 ltr./mtr; NW 200 – 40 ltr./mtr)

Outlet middle part

- To increase the outlet depth
- Construction height 300 mm

Outlet unit

- Sealed pipe connection DN 200 (KG coupling)
- Left/right rotation
- NW 150: DN 150 or DN 200 available
- NW 200: DN 200 or DN 300 available

Sustainability in action:

FILCOTEN® HPC (High Performance Concrete)

- Cement-bound, mineral material
- Extremely durable, stable and UV-resistant
- Extremely resistant to frost, de-icing salt, oil, petrol
- 100 % recyclable, certified ¹⁾
- Certified environmental and energy management to ISO 14001 or 50001 standards at the location in Oberwang/AT
- Tested by the IBR ²⁾ – safe in terms of sustainable building



www.say.bg/en/one_video

¹⁾ According to the guidelines of the Austrian Construction Material Recycling Association. ²⁾ Institute of Baubiologie Rosenheim.

up to class F 900

BG-FILCOTEN[®] one

BG-FILCOTEN[®] one, NW 150 mm / 6"

Monolithic channel made of FILCOTEN[®] HPC (High Performance Concrete) up to class F



Item no.	Monolithic channel body up to class F – without slope	Load class	Weight	Pcs./Pallet
15016100	one NW 150 no. 0, L = 1000 mm, SW 23/52 mm	D 400	76.6 kg	9
15016168	one NW 150 no. 40-0, L = 1000 mm, SW 23/52 mm	D 400	107.5 kg	6
15015100	one NW 150 no. 0, L = 1000 mm, SW 23/52 mm	F 900	76.6 kg	9
15015168	one NW 150 no. 40-0, L = 1000 mm, SW 23/52 mm	F 900	107.5 kg	6

BG-FILCOTEN[®] one NW 150: Inlet cross-section 370 cm²/m | Discharge cross-section 150/0: 220 cm²/m | 150/40-0: 520 cm²/m

Accessories

for BG-FILCOTEN[®] one, NW 150 mm / 6"

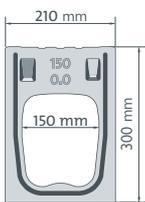

Item no.	Accessories	Load class	Weight
15015000	Variable corner element, no. 0, SW 23/52 mm	F 900	86.0 kg
15015008	Variable corner element, no. 40-0, SW 23/52 mm	F 900	118.7 kg
15016180	Maintenance unit no. 0, L = 1000 mm incl. ductile iron grating ¹⁾	D 400	83.0 kg
15016188	Maintenance unit no. 40-0, L = 1000 mm incl. ductile iron grating ¹⁾	D 400	111.0 kg
15015180	Maintenance unit no. 0, L = 1000 mm incl. ductile iron grating ¹⁾	F 900	83.0 kg
15015188	Maintenance unit no. 40-0, L=1000 mm incl. ductile iron grating ¹⁾	F 900	111.0 kg
15016190	Outlet unit no. 0, L=1000 incl. ductile iron grating, with outlet opening Ø 150 ¹⁾	D 400	82.0 kg
15016198	Outlet unit no. 40-0, L=1000 incl. ductile iron grating, with outlet opening Ø 150 ¹⁾	D 400	110.0 kg
15015190	Outlet unit no. 0, L=1000 incl. ductile iron grating, with outlet opening Ø 150 ¹⁾	F 900	82.0 kg
15015198	Outlet unit no. 40-0, L=1000 incl. ductile iron grating, with outlet opening Ø 150 ¹⁾	F 900	110.0 kg
15016170	Sump unit top part no. 0, L = 1000 mm incl. ductile iron grating ¹⁾	D 400	79.0 kg
15016178	Sump unit top part no. 40-0, L = 1000 mm incl. ductile iron grating ¹⁾	D 400	108.0 kg
15015170	Sump unit top part no. 0, L = 1000 mm incl. ductile iron grating ¹⁾	F 900	79.0 kg
15015178	Sump unit top part no. 40-0, L = 1000 mm incl. ductile iron grating ¹⁾	F 900	108.0 kg
19115094	Sump unit middle part, NW 150		28.0 kg
19115095	Sump unit, bottom part, NW 151, pipe-coupling Ø 150		33.8 kg
19115096	Sump unit, bottom part, NW 151, pipe-coupling Ø 200		33.3 kg
22510	Silt bucket for sump unit, plastic		0.4 kg
19115100	Front cap, no. 0, without outlet		7.3 kg
19115108	Front cap, no. 40-0, without outlet		12.3 kg
19115110	End cap no. 0, with outlet Ø 150		5.0 kg
19115118	End cap, no. 40-0, with outlet Ø 150		10.0 kg
19115157	Adapter cap no. 0 on 40-0		9.1 kg
19115900	Lifting-hook (set consisting of 2 pcs.), painted green		1.9 kg
19000701	Profile for joint sealing, no. 0, L = 650 mm ²⁾		0.04 kg
19000702	Profile for joint sealing, no. 40-0, L = 1050 mm ²⁾		0.07 kg
70154	pro pipe connector DN 200, L = 295 mm, (PVC-U) PVC		1.1 kg

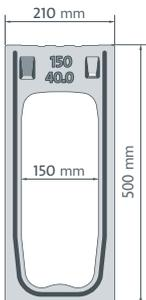

Maintenance unit or
Outlet element incl. ductile iron
grating

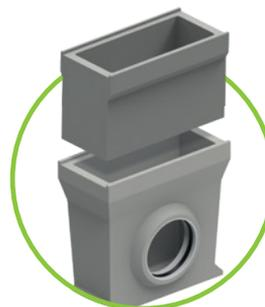

sump unit
middle part and lower part
DN 150 / 200 / 300

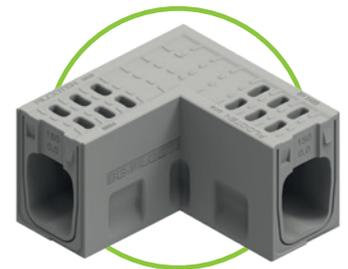

Corner piece variable



Lifting hook (consisting of 2 pcs.)
for NW 150, painted green



Lifting hook (consisting of 2 pcs.),
for NW 200, painted black



GRASPOINTNER
Sustainable innovation.

¹⁾ Comprising a monolithic channel body, cast iron edge and bolt-on ductile iron grating.
²⁾ Is a joint sealing profile required? Please contact our service team.

BG-FILCOTEN® one, NW 200 mm / 8"

Monolithic channel made of FILCOTEN® HPC (High Performance Concrete) up to class F

Item no.	monolithic channel body up to class F – without slope	Load class	Weight	Pcs./Pallet
15021100	one NW 200 no. 0, L = 1000 mm, SW 23/70 mm	D 400	106.0 kg	9
15021168	one NW 200 no. 40-0, L = 1000 mm, SW 23/70 mm	D 400	136.5 kg	6
15020100	one NW 200 no. 0, L = 1000 mm, SW 23/70 mm	F 900	106.0 kg	9
15020168	one NW 200 no. 40-0, L = 1000 mm, SW 23/70 mm	F 900	136.5 kg	6

BG-FILCOTEN® one NW 200: Inlet cross-section 510 cm²/m | Discharge cross-section 200/0: 340 cm²/m | 200/40-0: 735 cm²/m

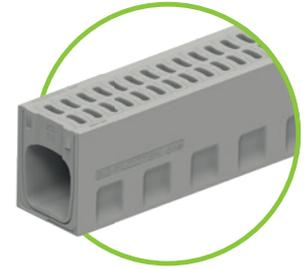

BG-FILCOTEN®

Accessories

for BG-FILCOTEN® one, NW 200 mm / 8"

Item no.	Accessories	Load class	Weight
15020000	Variable corner element, no. 0, SW 23/70 mm	F 900	114.0 kg
15020008	Variable corner element, no. 40-0, SW 23/70 mm	F 900	142.0 kg
15021180	Maintenance unit no. 0, L = 1000 mm incl. ductile iron grating ¹⁾	D 400	101.0 kg
15021188	Maintenance unit no. 40-0, L = 1000 mm incl. ductile iron grating ¹⁾	D 400	133.0 kg
15020180	Maintenance unit no. 0, L = 1000 mm incl. ductile iron grating ¹⁾	F 900	101.0 kg
15020188	Maintenance unit no. 40-0, L = 1000 mm incl. ductile iron grating ¹⁾	F 900	133.0 kg
15021190	Outlet unit no. 0, L = 1000 incl. ductile iron grating, with outlet opening Ø 200 ¹⁾	D 400	99.0 kg
15021198	Outlet unit no. 40-0, L = 1000 incl. ductile iron grating, with outlet opening Ø 200 ¹⁾	D 400	131.0 kg
15020190	Outlet unit no. 0, L = 1000 incl. ductile iron grating, with outlet opening Ø 200 ¹⁾	F 900	99.0 kg
15020198	Outlet unit no. 40-0, L = 1000 incl. ductile iron grating, with outlet opening Ø 200 ¹⁾	F 900	131.0 kg
15021170	Sump unit top part no. 0, L = 1000 mm incl. ductile iron grating ¹⁾	D 400	96.0 kg
15021178	Sump unit top part no. 40-0, L = 1000 mm incl. ductile iron grating ¹⁾	D 400	128.0 kg
15020170	Sump unit top part no. 0, L = 1000 mm incl. ductile iron grating ¹⁾	F 900	96.0 kg
15020178	Sump unit top part no. 40-0, L = 1000 mm incl. ductile iron grating ¹⁾	F 900	128.0 kg
19120094	Sump unit middle part, NW 200		29.0 kg
19120095	Sump unit, bottom part, NW 201, pipe-coupling Ø 200		35.5 kg
19120096	Sump unit, bottom part, NW 201, pipe-coupling Ø 300		39.0 kg
22511	Silt bucket for sump unit, plastic		0.7 kg
19120100	Front cap, no. 0, without outlet		13.0 kg
19120108	Front cap, no. 40-0, without outlet		21.0 kg
19120110	End cap no. 0, with outlet Ø 200		8.5 kg
19120118	End cap, no. 40-0, with outlet Ø 200		16.5 kg
19120157	Adapter cap no. 0 on 40-0		12.5 kg
19120900	Lifting hook (consisting of 2 pcs.), painted black		2.1 kg
19000703	Profile for joint sealing, no. 0, L = 760 mm ²⁾		0.05 kg
19000704	Profile for joint sealing, no. 40-0, L = 1160 mm ²⁾		0.08 kg
70154	pro pipe connector DN 200, L = 295 mm, (PVC-U) PVC		1.1 kg

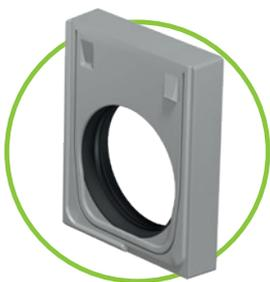
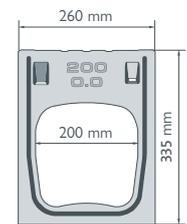

End cap with outlet



Front cap closed



Adapter cap no. 0 / 40-0

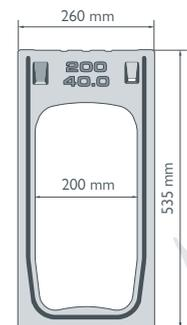

For sectional drawings and technical data on sump units, please contact
CA: technical@bg-graspointner.com
USA: sales.usa@bg-graspointner.com

²⁾ Is a joint sealing profile required?
Please say so with your order.



Perfect for everyday
challenges & any
other challenges too.

BG-FLEX

Our steel channel systems are as varied as your requirements. Known for our intelligent and innovative designs, continuous improvement, high-quality materials and reliable production processes, the strengths of BG shine through in our products. Even if your project is absolutely unique, we will still find the optimum solution with our individually customised products.



GRASPOINTNER
Sustainable innovation.

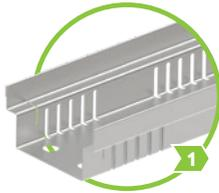

BG-FLEX FA
facade channels
accessible
pages 64 – 73



BG-FLEX TE
terrace slot channels
accessible
page 74



BG-FLEX TM
terrace channels
accessible
page 75



BG-FLEX stone
terrace channel
accessible
pages 76 – 77



BG-FLEX omega
up to class C 250
pages 80 – 83



BG-FLEX sigma tec
up to load class C 250
pages 84 – 87



Technical data CA: www.say.bg/31/bg-flex
Technical data USA: www.say.bg/12/bg-flex



On demand.

BG-FLEX channel systems sorted by application areas:

Facade	1 2 3 4 5 6	Terrace	1 2 3 4 5 6
Flat roof	1 2 3 4 5 6	Underground car park	1 2 3 4 5 6
Landscape construction	1 2 3 4 5 6	Wine yard	1 2 3 4 5 6
Parking decks & garages	1 2 3 4 5 6	Garage	1 2 3 4 5 6
Slot drainage	1 2 3 4 5 6		



BG-FLEX FA

Facade channel

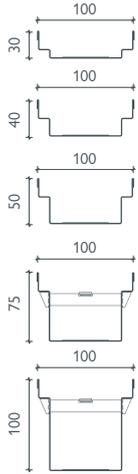
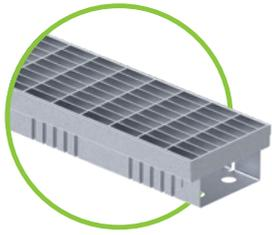

Fixed construction height

BG-FLEX FA facade channel, width 100 mm / 4" – GALVANIZED STEEL

perforated on both sides (except accessory elements) or closed, galvanized steel (V)

Item no.	Perforated channel body – material thickness 1.00 mm	Length mm	Height mm	Weight
23010201	FA facade channel V, width 100	1000	30	1.3 kg
23010202	FA facade channel V, width 100	2000	30	2.6 kg
23010203	FA facade channel V, width 100	1000	40	1.5 kg
23010204	FA facade channel V, width 100	2000	40	2.9 kg
23010205	FA facade channel V, width 100	1000	50	1.6 kg
23010206	FA facade channel V, width 100	2000	50	3.2 kg
23010207	FA facade channel V, width 100	1000	75	2.1 kg
23010208	FA facade channel V, width 100	2000	75	4.1 kg
23010209	FA facade channel V, width 100	1000	100	2.5 kg
23010210	FA facade channel V, width 100	2000	100	4.9 kg
Item no.	Closed channel body – material thickness 1.00 mm	Length mm	Height mm	Weight
23010221	FA facade channel V, width 100	1000	30	1.4 kg
23010222	FA facade channel V, width 100	2000	30	2.8 kg
23010223	FA facade channel V, width 100	1000	40	1.6 kg
23010224	FA facade channel V, width 100	2000	40	3.1 kg
23010225	FA facade channel V, width 100	1000	50	1.7 kg
23010226	FA facade channel V, width 100	2000	50	3.4 kg
23010227	FA facade channel V, width 100	1000	75	2.2 kg
23010228	FA facade channel V, width 100	2000	75	4.3 kg
23010229	FA facade channel V, width 100	1000	100	2.6 kg
23010230	FA facade channel V, width 100	2000	100	5.1 kg
Item no.	Closed outlet unit incl. outlet pipe Ø 50	Material	Height mm	Weight
23010251	FA outlet unit V, width 100, L = 1000	galvanized steel	30	1.4 kg
23010252	FA outlet unit V, width 100, L = 1000	galvanized steel	40	1.5 kg
23010253	FA outlet unit V, width 100, L = 1000	galvanized steel	50	1.7 kg
23010254	FA outlet unit V, width 100, L = 1000	galvanized steel	75	2.1 kg
23010255	FA outlet unit V, width 100, L = 1000	galvanized steel	100	2.5 kg
Item no.	Gratings – width 100 mm / height 20 mm	Material	Pcs./Pallet	Weight
23510201	FA mesh grating, 1000/100/20/2, MW 30/10	galvanized steel	238	2.1 kg
23510202	FA mesh grating, 500/100/20/2, MW 30/10	galvanized steel	56	1.1 kg
23510203	FA longitudinal bar grating, 1000/100/20/2, bar distance 10	galvanized steel	238	3.3 kg
23510204	FA longitudinal bar grating, 500/100/20/2, bar distance 10	galvanized steel	56	1.7 kg
Item no.	Accessories	Material	Height mm	Weight
23910221	FA front cap V, width 100	galvanized steel	30, 40	0.1 kg
23910222	FA front cap V, width 100	galvanized steel	50, 75, 100	0.1 kg
23910231	FA connection sleeve for channels with CH 50, 75, 100	galvanized steel	28	0.1 kg
24909012	FA Flat head bolts for locking of mesh, slotted and longitudinal bar gratings (required per m: 2 pcs.)	galvanized steel		0.1 kg
24900022	FA bolting-material set for mesh and longitudinal bar gratings: locking bar incl. press nut and pan head screw for CH 40/50 (required per m: 2 pcs.)	galvanized steel		0.1 kg



Other construction heights on request



Please note the delivery time may be longer for this product group!



BG-FLEX FA facade channel, width 100 mm / 4" – STAINLESS STEEL

perforated on both sides (except accessory elements) or closed, stainless steel (E)

Item no.	Perforated channel body – material thickness 1.00 mm	Length mm	Height mm	Weight
23010301	FA facade channel E, width 100	1000	30	1.4 kg
23010302	FA facade channel E, width 100	2000	30	2.7 kg
23010303	FA facade channel E, width 100	1000	40	1.6 kg
23010304	FA facade channel E, width 100	2000	40	3.0 kg
23010305	FA facade channel E, width 100	1000	50	1.7 kg
23010306	FA facade channel E, width 100	2000	50	3.3 kg
23010307	FA facade channel E, width 100	1000	75	2.2 kg
23010308	FA facade channel E, width 100	2000	75	4.2 kg
23010309	FA facade channel E, width 100	1000	100	2.6 kg
23010310	FA facade channel E, width 100	2000	100	5.0 kg
Item no.	Closed channel body – material thickness 1.00 mm	Length mm	Height mm	Weight
23010321	FA facade channel E, width 100	1000	30	1.5 kg
23010322	FA facade channel E, width 100	2000	30	2.9 kg
23010323	FA facade channel E, width 100	1000	40	1.7 kg
23010324	FA facade channel E, width 100	2000	40	3.2 kg
23010325	FA facade channel E, width 100	1000	50	1.8 kg
23010326	FA facade channel E, width 100	2000	50	3.5 kg
23010327	FA facade channel E, width 100	1000	75	2.3 kg
23010328	FA facade channel E, width 100	2000	75	4.4 kg
23010329	FA facade channel E, width 100	1000	100	2.7 kg
23010330	FA facade channel E, width 100	2000	100	5.2 kg
Item no.	Closed outlet unit incl. outlet pipe Ø 50	Material	Height mm	Weight
23010351	FA outlet unit E, width 100, L = 1000	stainless steel	30	1.4 kg
23010352	FA outlet unit E, width 100, L = 1000	Stainless steel	40	1.5 kg
23010353	FA outlet unit E, width 100, L = 1000	stainless steel	50	1.7 kg
23010354	FA outlet unit E, width 100, L = 1000	stainless steel	75	2.1 kg
23010355	FA outlet unit E, width 100, L = 1000	stainless steel	100	2.5 kg
Item no.	Gratings – width 100 mm / height 20 mm	Material	Pcs./Pallet	Weight
23510301	FA mesh grating, 1000/100/20/2, MW 30/10	stainless steel	238	2.1 kg
23510302	FA mesh grating 500/100/20/2, MW 30/10	stainless steel	56	1.1 kg
23510303	FA longitudinal bar grating, 1000/100/20/2, bar distance 10	stainless steel	238	3.3 kg
23510304	FA longitudinal bar grating, 500/100/20/2, bar distance 10	stainless steel	56	1.7 kg
23510305	FA design-longitudinal bar grating 1000/100/20/2, bar distance 6	stainless steel	224	2.6 kg
23510306	FA design-longitudinal bar grating 500/100/20/2, bar distance 6	stainless steel	48	1.3 kg
Item no.	Accessories	Material	Height mm	Weight
23910321	FA front cap V, width 100	stainless steel	30, 40	0.1 kg
23910322	FA front cap V, width 100	stainless steel	50, 75, 100	0.1 kg
23910331	FA connection sleeve for channels with CH 50, 75, 100	stainless steel	28	0.1 kg
24909013	Pan head screw for locking of mesh, slotted and longitudinal bar gratings (required per m: 2 pcs.)	stainless steel		0.1 kg
24900023	FA bolting-material set for mesh and longitudinal bar gratings: locking bar incl. press nut and pan head screw for CH 40/50 (required per m: 2 pcs.)	stainless steel		0.1 kg

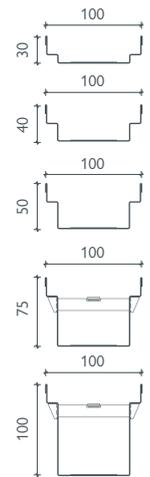
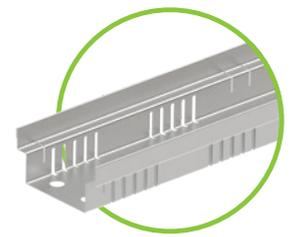

Fixed construction height

i Other construction heights on request

i All FA facade channels incl. gratings are walkable and wheelchair-safe! 

References

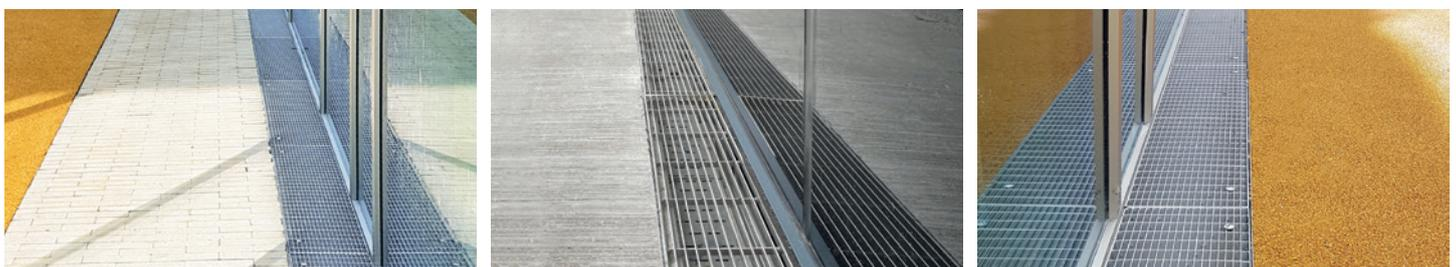



BG-FLEX FA

Facade channel

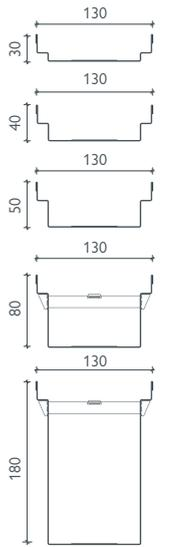
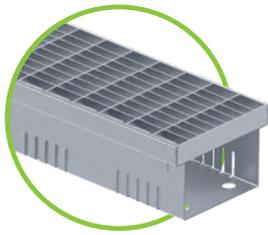

Fixed construction height

BG-FLEX FA facade channel, width 130 mm / 5" – GALVANIZED STEEL

perforated on both sides (except accessory elements) or closed, galvanized steel (V)

Item no.	Perforated channel body – material thickness 1.00 mm	Length mm	Height mm	Weight
23013201	FA facade channel V, width 130	1000	30	1.7 kg
23013202	FA facade channel V, width 130	2000	30	3.3 kg
23013203	FA facade channel V, width 130	1000	40	1.8 kg
23013204	FA facade channel V, width 130	2000	40	3.6 kg
23013205	FA facade channel V, width 130	1000	50	2.0 kg
23013206	FA facade channel V, width 130	2000	50	4.0 kg
23013207	FA facade channel V, width 130	1000	80	2.4 kg
23013208	FA facade channel V, width 130	2000	80	4.8 kg
23013211	FA facade channel V, width 130	1000	180	3.5 kg
23013212	FA facade channel V, width 130	2000	180	7.0 kg
Item no.	Closed channel body – material thickness 1.00 mm	Length mm	Height mm	Weight
23013221	FA facade channel V, width 130	1000	30	1.7 kg
23013222	FA facade channel V, width 130	2000	30	3.3 kg
23013223	FA facade channel V, width 130	1000	40	1.8 kg
23013224	FA facade channel V, width 130	2000	40	3.6 kg
23013225	FA facade channel V, width 130	1000	50	2.0 kg
23013226	FA facade channel V, width 130	2000	50	4.0 kg
23013227	FA facade channel V, width 130	1000	80	2.4 kg
23013228	FA facade channel V, width 130	2000	80	4.8 kg
23013231	FA facade channel V, width 130	1000	180	3.5 kg
23013232	FA facade channel V, width 130	2000	180	7.0 kg
Item no.	Closed outlet unit incl. outlet pipe Ø 75	Material	Height mm	Weight
23013251	FA outlet unit V, width 130, L = 1000	galvanized steel	30	1.5 kg
23013252	FA outlet unit V, width 130, L = 1000	galvanized steel	40	1.7 kg
23013253	FA outlet unit V, width 130, L = 1000	galvanized steel	50	1.9 kg
23013254	FA outlet unit V, width 130, L = 1000	galvanized steel	80	2.4 kg
23013255	FA outlet unit V, width 130, L = 1000	galvanized steel	180	4.0 kg
Item no.	Gratings – width 122 mm / height 20 mm	Material	Pcs./Pallet	Weight
23513203	FA Mesh grating, 1000/122/20, MW 30/10, T-profile	galvanized steel	120	3.4 kg
24513201	FA mesh grating, 1000/122/20, MW 30/10	galvanized steel	120	2.5 kg
24513202	FA mesh grating, 500/122/20, MW 30/10	galvanized steel	48	1.3 kg
24513203	FA slotted grating 1000/122/20, SW 9/80	galvanized steel	120	2.0 kg
24513204	FA slotted grating 500/122/20, SW 9/80	galvanized steel	48	1.0 kg
24513205	FA perforated grating, 1000/122/20, Ø 6	galvanized steel	120	1.6 kg
24513206	FA perforated grating, 500/122/20, Ø 6	galvanized steel	48	0.8 kg
24513207	FA longitudinal bar grating, 1000/122/20, bar distance 10	galvanized steel	120	3.9 kg
24513208	FA longitudinal bar grating, 500/122/20, bar distance 10	galvanized steel	48	2.0 kg
23513205	FA longitudinal bar grating, 500/122/20, grey	plastic	120	0.2 kg
Item no.	Accessories	Material	Height mm	Weight
23913221	FA front cap V, width 130	galvanized steel	30, 40	0.1 kg
23913222	FA front cap V, width 130	galvanized steel	50	0.1 kg
23913223	FA front cap V, width 130	galvanized steel	80	0.1 kg
23913224	FA front cap V, width 130	galvanized steel	180	0.1 kg
23913231	FA connection sleeve for channels with CH 50, 80, 180	galvanized steel	28	0.1 kg
24909012	Pan head screw for locking of mesh, slotted and longitudinal bar gratings (required per m: 2 pcs.)	galvanized steel		0.1 kg
24900018	FA bolting-material set for mesh and longitudinal bar gratings: locking bar incl. press nut and pan head screw for CH 40/50 (required per m: 2 pcs.)	galvanized steel		0.1 kg

i Other construction heights on request

i All FA facade channels incl. gratings are walkable and wheelchair-safe!

i Please note the delivery time may be longer for this product group!

BG-FLEX FA facade channel, width 130 mm / 5" – STAINLESS STEEL

perforated on both sides (except accessory elements) or closed, stainless steel (E)

Item no.	Perforated channel body – material thickness 1.00 mm	Length mm	Height mm	Weight
23013301	FA facade channel E, width 130	1000	30	1.6 kg
23013302	FA facade channel E, width 130	2000	30	3.3 kg
23013303	FA facade channel E, width 130	1000	40	1.8 kg
23013304	FA facade channel E, width 130	2000	40	3.6 kg
23013305	FA facade channel E, width 130	1000	50	2.0 kg
23013306	FA facade channel E, width 130	2000	50	4.0 kg
23013307	FA facade channel E, width 130	1000	80	2.4 kg
23013308	FA facade channel E, width 130	2000	80	4.8 kg
23013311	FA facade channel E, width 130	1000	180	3.5 kg
23013312	FA facade channel E, width 130	2000	180	7.0 kg
Item no.	Closed outlet unit incl. outlet pipe Ø 75	Material	Height mm	Weight
23013351	FA outlet unit E, width 130, L = 1000	stainless steel	30	1.5 kg
23013352	FA outlet unit E, width 130, L = 1000	stainless steel	40	1.7 kg
23013353	FA outlet unit E, width 130, L = 1000	stainless steel	50	1.9 kg
23013354	FA outlet unit E, width 130, L = 1000	stainless steel	80	2.4 kg
23013355	FA outlet unit E, width 130, L = 1000	stainless steel	180	4.0 kg
Item no.	Gratings – width 122 mm / height 20 mm	Material	Pcs./Pallet	Weight
24513301	FA mesh grating, 1000/122/20, MW 30/10	stainless steel	120	3.1 kg
24513302	FA mesh grating, 500/122/20, MW 30/10	stainless steel	48	1.5 kg
24513303	FA slotted grating, 1000/122/20, SW 9/80	stainless steel	120	2.0 kg
24513304	FA slotted grating, 500/122/20, SW 9/80	stainless steel	48	1.0 kg
24513305	FA perforated grating, 1000/122/20, Ø 6	stainless steel	120	1.6 kg
24513306	FA perforated grating, 500/122/20, Ø 6	stainless steel	48	0.8 kg
24513307	FA longitudinal bar grating, 1000/122/20, bar distance 10	stainless steel	120	4.2 kg

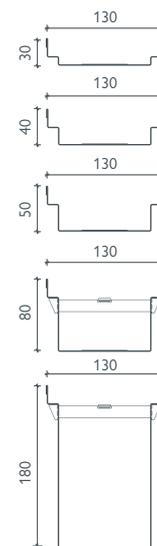
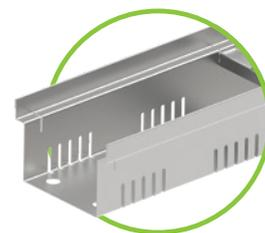

Fixed construction height

i Other construction heights on request

References

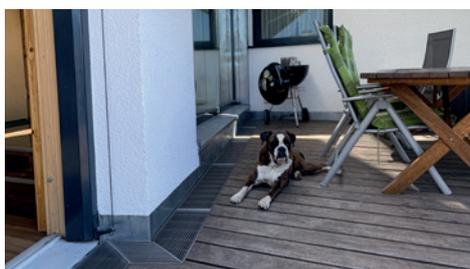
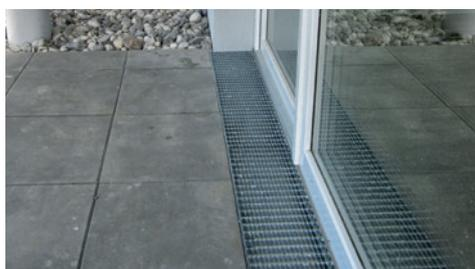



BG-FLEX FA

Facade channel

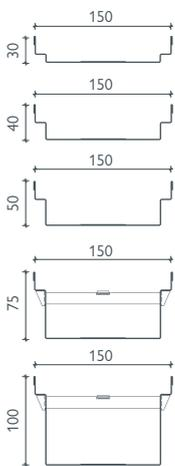
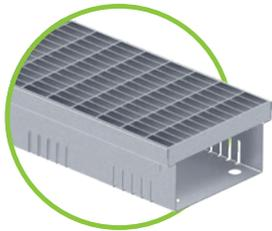

Fixed construction height

BG-FLEX FA facade channel, width 150 mm / 6" – GALVANIZED STEEL

perforated on both sides (except accessory elements) or closed, galvanized steel (V)

Item no.	Perforated channel body – material thickness 1.00 mm	Length mm	Height mm	Weight
23015201	FA facade channel V, width 150	1000	30	1.7 kg
23015202	FA facade channel V, width 150	2000	30	3.4 kg
23015203	FA facade channel V, width 150	1000	40	1.9 kg
23015204	FA facade channel V, width 150	2000	40	3.7 kg
23015205	FA facade channel V, width 150	1000	50	2.0 kg
23015206	FA facade channel V, width 150	2000	50	4.0 kg
23015207	FA facade channel V, width 150	1000	75	2.5 kg
23015208	FA facade channel V, width 150	2000	75	5.0 kg
23015209	FA facade channel V, width 150	1000	100	2.9 kg
23015210	FA facade channel V, width 150	2000	100	5.8 kg
Item no.	Closed channel body – material thickness 1.00 mm	Length mm	Height mm	Weight
23015221	FA facade channel V, width 150	1000	30	1.8 kg
23015222	FA facade channel V, width 150	2000	30	3.6 kg
23015223	FA facade channel V, width 150	1000	40	2.0 kg
23015224	FA facade channel V, width 150	2000	40	3.9 kg
23015225	FA facade channel V, width 150	1000	50	2.1 kg
23015226	FA facade channel V, width 150	2000	50	4.2 kg
23015227	FA facade channel V, width 150	1000	75	2.6 kg
23015228	FA facade channel V, width 150	2000	75	5.2 kg
23015229	FA facade channel V, width 150	1000	100	3.0 kg
23015230	FA facade channel V, width 150	2000	100	5.9 kg
Item no.	Closed outlet unit incl. outlet pipe Ø 100	Material	Height mm	Weight
23015251	FA outlet unit V, width 150, L = 1000	galvanized steel	30	1.8 kg
23015252	FA outlet unit V, width 150, L = 1000	galvanized steel	40	1.9 kg
23015253	FA outlet unit V, width 150, L = 1000	galvanized steel	50	2.0 kg
23015254	FA outlet unit V, width 150, L = 1000	galvanized steel	75	2.5 kg
23015255	FA outlet unit V, width 150, L = 1000	galvanized steel	100	2.9 kg
Item no.	Gratings – width 150 mm / height 20 mm	Material	Pcs./Pallet	Weight
23515201	FA mesh grating, 1000/150/20/2, MW 30/10	galvanized steel	170	3.0 kg
23515202	FA mesh grating, 500/150/20/2, MW 30/10	galvanized steel	54	1.5 kg
23515203	FA longitudinal bar grating, 1000/150/20/2, bar distance 10	galvanized steel	170	4.6 kg
23515204	FA longitudinal bar grating, 500/150/20/2, bar distance 10	galvanized steel	54	2.3 kg
Item no.	Accessories	Material	Height mm	Weight
23915221	FA front cap V, width 150	galvanized steel	30, 40	0.1 kg
23915222	FA front cap V, width 150	galvanized steel	50, 75, 100	0.1 kg
23915231	FA connection sleeve for channels with CH 50, 75, 100	galvanized steel	28	0.1 kg
24909012	Pan head screw for locking of mesh, slotted and longitudinal bar gratings (required per m: 2 pcs.)	galvanized steel		0.1 kg
24900024	FA bolting-material set for mesh and longitudinal bar gratings: locking bar incl. press nut and pan head screw for CH 40/50 (required per m: 2 pcs.)	galvanized steel		0.1 kg

i Other construction heights on request

i Please note the delivery time may be longer for this product group!

BG-FLEX FA facade channel, width 150 mm / 6" – STAINLESS STEEL

perforated on both sides (except accessory elements) or closed, stainless steel (E)

Item no.	Perforated channel body – material thickness 1.00 mm	Length mm	Height mm	Weight
23015301	FA facade channel E, width 150	1000	30	1.8 kg
23015302	FA facade channel E, width 150	2000	30	3.5 kg
23015303	FA facade channel E, width 150	1000	40	1.9 kg
23015304	FA facade channel E, width 150	2000	40	3.8 kg
23015305	FA facade channel E, width 150	1000	50	2.1 kg
23015306	FA facade channel E, width 150	2000	50	4.1 kg
23015307	FA facade channel E, width 150	1000	75	2.6 kg
23015308	FA facade channel E, width 150	2000	75	5.1 kg
23015309	FA facade channel E, width 150	1000	100	3.0 kg
23015310	FA facade channel E, width 150	2000	100	5.9 kg
Item no.	Closed channel body – material thickness 1.00 mm	Length mm	Height mm	Weight
23015321	FA facade channel E, width 150	1000	30	1.8 kg
23015322	FA facade channel E, width 150	2000	30	3.6 kg
23015323	FA facade channel E, width 150	1000	40	2.0 kg
23015324	FA facade channel E, width 150	2000	40	3.9 kg
23015325	FA facade channel E, width 150	1000	50	2.2 kg
23015326	FA facade channel E, width 150	2000	50	4.3 kg
23015327	FA facade channel E, width 150	1000	75	2.7 kg
23015328	FA facade channel E, width 150	2000	75	5.3 kg
23015329	FA facade channel E, width 150	1000	100	3.1 kg
23015330	FA facade channel E, width 150	2000	100	6.1 kg
Item no.	Closed outlet unit incl. outlet pipe Ø 100	Material	Height mm	Weight
23015351	FA outlet unit E, width 150, L = 1000	stainless steel	30	1.8 kg
23015352	FA outlet unit E, width 150, L = 1000	stainless steel	40	2.0 kg
23015353	FA outlet unit E, width 150, L = 1000	stainless steel	50	2.1 kg
23015354	FA outlet unit E, width 150, L = 1000	stainless steel	75	2.6 kg
23015355	FA outlet unit E, width 150, L = 1000	stainless steel	100	3.0 kg
Item no.	Gratings – width 150 mm / height 20 mm	Material	Pcs./Pallet	Weight
23515301	FA mesh grating, 1000/150/20/2, MW 30/10	stainless steel	170	2.9 kg
23515302	FA mesh grating, 500/150/20/2, MW 30/10	stainless steel	54	1.5 kg
23515303	FA longitudinal bar grating, 1000/150/20/2, bar distance 10	stainless steel	170	4.6 kg
23515304	FA longitudinal bar grating, 500/150/20/2, bar distance 10	stainless steel	54	2.3 kg
23515305	FA design-longitudinal bar grating, 1000/150/20/2, bar distance 6	stainless steel	80	3.6 kg
23515306	FA design-longitudinal bar grating 500/150/20/2, bar distance 6	stainless steel	54	1.7 kg
Item no.	Accessories	Material	Height mm	Weight
23915321	FA front cap E, width 150	stainless steel	30, 40	0.1 kg
23915322	FA front cap E, width 150	stainless steel	50, 75, 100	0.1 kg
23915331	FA connection sleeve for channels with CH 50, 75, 100	stainless steel	28	0.1 kg
24909013	Pan head screw for locking of mesh, slotted and longitudinal bar gratings (required per m: 2 pcs.)	stainless steel		0.1 kg
24900025	FA bolting-material set for mesh and longitudinal bar gratings: locking bar incl. press nut and pan head screw for CH 40/50 (required per m: 2 pcs.)	stainless steel		0.1 kg

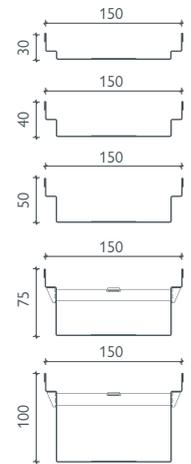
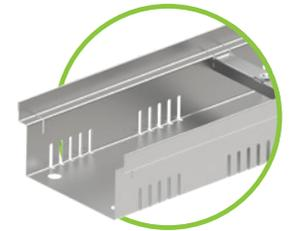

Fixed construction height

i Other construction heights on request

i All FA facade channels incl. gratings are walkable and wheelchair-safe! 





BG-FLEX FA

Facade channel

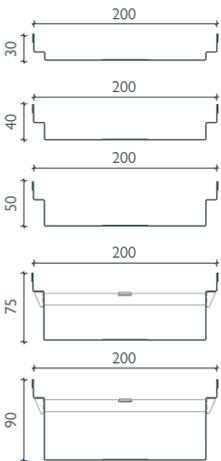
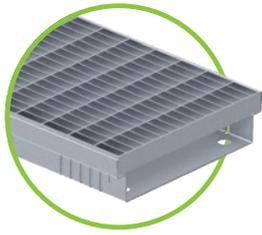

Fixed construction height

BG-FLEX FA facade channel, width 200 mm / 8" – GALVANIZED STEEL

perforated on both sides (except accessory elements) or closed, galvanized steel (V)

Item no.	Perforated channel body – material thickness 1.00 mm	Length mm	Height mm	Weight
23020201	FA facade channel V, width 200	1000	30	2.3 kg
23020202	FA facade channel V, width 200	2000	30	4.5 kg
23020203	FA facade channel V, width 200	1000	40	2.4 kg
23020204	FA facade channel V, width 200	2000	40	4.8 kg
23020205	FA facade channel V, width 200	1000	50	2.6 kg
23020206	FA facade channel V, width 200	2000	50	5.2 kg
23020207	FA facade channel V, width 200	1000	75	3.0 kg
23020208	FA facade channel V, width 200	2000	75	6.0 kg
23020209	FA facade channel V, width 200	1000	90	3.3 kg
23020210	FA facade channel V, width 200	2000	90	6.5 kg
Item no.	Closed channel body – material thickness 1.00 mm	Length mm	Height mm	Weight
23020221	FA facade channel V, width 200	1000	30	2.3 kg
23020222	FA facade channel V, width 200	2000	30	4.5 kg
23020223	FA facade channel V, width 200	1000	40	2.4 kg
23020224	FA facade channel V, width 200	2000	40	4.8 kg
23020225	FA facade channel V, width 200	1000	50	2.6 kg
23020226	FA facade channel V, width 200	2000	50	5.2 kg
23020227	FA facade channel V, width 200	1000	75	3.0 kg
23020228	FA facade channel V, width 200	2000	75	6.0 kg
23020229	FA facade channel V, width 200	1000	90	3.3 kg
23020230	FA facade channel V, width 200	2000	90	6.5 kg
Item no.	Accessible channel body – material thickness 1.00 mm	Length mm	Height mm	Weight
21020251	FA facade channel V, width 200, different leg height	1000	50 / 60	2.7 kg
21020252	FA facade channel V, width 200, different leg height	2000	50 / 60	5.3 kg
Item no.	Closed outlet unit incl. outlet pipe Ø 100	Material	Height mm	Weight
23020251	FA outlet unit V, width 200, L = 1000	galvanized steel	30	2.1 kg
23020252	FA outlet unit V, width 200, L = 1000	galvanized steel	40	2.3 kg
23020253	FA outlet unit V, width 200, L = 1000	galvanized steel	50	2.5 kg
23020254	FA outlet unit V, width 200, L = 1000	galvanized steel	75	3.0 kg
23020255	FA outlet unit V, width 200, L = 1000	galvanized steel	90	3.2 kg
Item no.	Gratings – width 200 mm / height 20 mm	Material	Pcs./Pallet	Weight
24520201	FA mesh grating, 1000/200/20, MW 30/10	galvanized steel	60	3.8 kg
24520202	FA mesh grating, 500/200/20, MW 30/10	galvanized steel	30	2.0 kg
23520203	FA mesh grating, 1000/200/20, MW 30/10 T-profile	galvanized steel	60	5.3 kg
24520203	FA longitudinal bar grating 1000/200/20, bar distance 10	galvanized steel	60	6.4 kg
24520204	FA longitudinal bar grating 500/200/20, bar distance 10	galvanized steel	30	3.2 kg
23520205	FA longitudinal bar grating, 500/200/20, grey	plastic	80	0.3 kg
23520201	FA slotted grating, 1000/200/20	galvanized steel	60	2.3 kg
24520207	FA perforated grating 1000/200/20, Ø 6	galvanized steel	60	3.5 kg
24520208	FA perforated grating 500/200/20, Ø 6	galvanized steel	30	1.7 kg
Item no.	Accessories	Material	Height mm	Weight
23920221	FA front cap V, width 200	galvanized steel	30, 40	0.1 kg
23920222	FA front cap V, width 200	galvanized steel	50	0.1 kg
23920223	FA front cap V, width 200	galvanized steel	75	0.1 kg
23920224	FA front cap V, width 200	galvanized steel	90	0.1 kg
23920231	FA connection sleeve for channels with CH 50, 75, 90	galvanized steel	28	0.1 kg
24909012	Pan head screw for locking of mesh, slotted and longitudinal bar gratings (required per m: 2 pcs.)	galvanized steel		0.1 kg
24900012	FA bolting-material set for mesh and longitudinal bar gratings: locking bar incl. press nut and pan head screw for CH 40/50 (required per m: 2 pcs.)	galvanized steel		0.1 kg



Other construction heights on request



All FA facade channels incl. gratings are walkable and wheelchair-safe!



Please note the delivery time may be longer for this product group!



GRASPOINTNER
Sustainable innovation.



BG-FLEX FA facade channel, width 200 mm / 8" – STAINLESS STEEL

perforated on both sides (except accessory elements) or closed, stainless steel (E)

Item no.	Perforated channel body – material thickness 1.00 mm	Length mm	Height mm	Weight
23020301	FA facade channel E, width 200	1000	30	2.2 kg
23020302	FA facade channel E, width 200	2000	30	4.5 kg
23020303	FA facade channel E, width 200	1000	40	2.4 kg
23020304	FA facade channel E, width 200	2000	40	4.8 kg
23020305	FA facade channel E, width 200	1000	50	2.6 kg
23020306	FA facade channel E, width 200	2000	50	5.2 kg
23020307	FA facade channel E, width 200	1000	75	3.0 kg
23020308	FA facade channel E, width 200	2000	75	6.0 kg
23020309	FA facade channel E, width 200	1000	90	3.3 kg
23020310	FA facade channel E, width 200	2000	90	6.5 kg
Item no.	Closed channel body – material thickness 1.00 mm	Length mm	Height mm	Weight
23020321	FA facade channel E, width 200	1000	30	2.2 kg
23020322	FA facade channel E, width 200	2000	30	4.5 kg
23020323	FA facade channel E, width 200	1000	40	2.4 kg
23020324	FA facade channel E, width 200	2000	40	4.8 kg
23020325	FA facade channel E, width 200	1000	50	2.6 kg
23020326	FA facade channel E, width 200	2000	50	5.2 kg
23020327	FA facade channel E, width 200	1000	75	3.0 kg
23020328	FA facade channel E, width 200	2000	75	6.0 kg
23020329	FA facade channel E, width 200	1000	90	3.3 kg
23020330	FA facade channel E, width 200	2000	90	6.5 kg
Item no.	Closed outlet unit incl. outlet pipe Ø 100	Material	Height mm	Weight
23020351	FA outlet unit E, width 200, L = 1000	stainless steel	30	2.1 kg
23020352	FA outlet unit E, width 200, L = 1000	stainless steel	40	2.3 kg
23020353	FA outlet unit E, width 200, L = 1000	stainless steel	50	2.5 kg
23020354	FA outlet unit E, width 200, L = 1000	stainless steel	75	3.0 kg
23020355	FA outlet unit E, width 200, L = 1000	stainless steel	90	3.2 kg
Item no.	Gratings – width 200 mm / height 20 mm	Material	Pcs./Pallet	Weight
24520301	FA mesh grating, 1000/200/20, MVV 30/10	stainless steel	60	3.8 kg
24520302	FA mesh grating, 500/200/20, MVV 30/10	stainless steel	30	2.4 kg
24520303	FA longitudinal bar grating, 1000/200/20, bar distance 10	stainless steel	60	6.5 kg
24520304	FA longitudinal bar grating, 500/200/20, bar distance 10	stainless steel	30	3.3 kg
23520301	FA slotted grating, 1000/200/20	stainless steel	60	2.2 kg
24520307	FA perforated grating, 1000/200/20, Ø 6	stainless steel	60	3.5 kg
24520308	FA perforated grating, 500/200/20, Ø 6	stainless steel	30	1.7 kg
23520305	FA design-longitudinal bar grating, 1000/200/20/2, bar distance 6	stainless steel	78	5.0 kg
23520306	FA design-longitudinal bar grating, 500/200/20/2, bar distance 6	stainless steel	42	2.1 kg
Item no.	Accessories	Material	Height mm	Weight
23920321	FA front cap E, width 200	stainless steel	30, 40	0.1 kg
23920322	FA front cap E, width 200	stainless steel	50	0.1 kg
23920323	FA front cap E, width 200	stainless steel	75, 90	0.1 kg
23920331	FA connection sleeve for channels with CH 50, 75, 90	stainless steel	28	0.1 kg
24909013	Pan head screw for locking of mesh, slotted and longitudinal bar gratings (required per m: 2 pcs.)	stainless steel		0.1 kg
24900013	FA bolting-material set for mesh and longitudinal bar gratings: locking bar incl. press nut and pan head screw for CH 40/50 (required per m: 2 pcs.)	stainless steel		0.1 kg

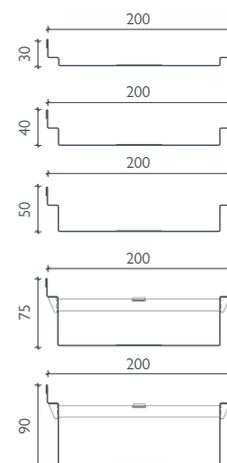
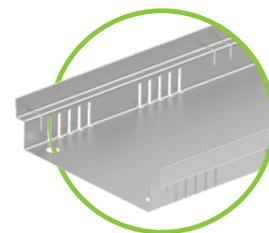

Fixed construction height

i Other construction heights on request

References

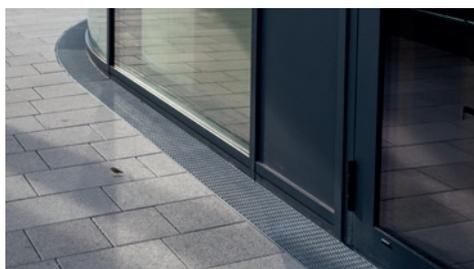

BG-FLEX FA

Facade channel



FA gully top with mesh grating

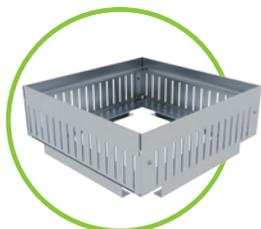

FA add-on frame for gully top

BG-FLEX FA gully top

suitable as sump or maintenance unit with inserted mesh gratings

Item no.	Gully tops – material thickness 1,00 mm	Material	Height mm	Weight
23900206	FA gully top V 150/150, fixed construction height	galvanized steel	60	0.5 kg
23900207	FA gully top V 150/150, fixed construction height	galvanized steel	100	0.7 kg
23900208	FA gully top V 150/150, fixed construction height	galvanized steel	150	0.8 kg
23900212	Distance frame for height adjustment 150/150, fixed construction height	galvanized steel	20	0.2 kg
23900214	Distance frame for height adjustment 150/150, fixed construction height	galvanized steel	50	0.3 kg
23900201	FA gully top V 200/200, fixed construction height	galvanized steel	60	0.6 kg
23900202	FA gully top V 200/200, fixed construction height	galvanized steel	100	0.9 kg
23900203	FA gully top V 200/200, fixed construction height	galvanized steel	150	1.2 kg
23900205	Distance frame for height adjustment 200/200, fixed construction height	galvanized steel	20	0.3 kg
23900215	Distance frame for height adjustment 200/200, fixed construction height	galvanized steel	50	0.5 kg
24925200	FA gully top V 250/250, fixed construction height	galvanized steel	50	1.9 kg
24925201	FA gully top V 250/250, variable construction height	galvanized steel	70 – 100	2.6 kg
24925202	FA gully top V 250/250, variable construction height	galvanized steel	100 – 160	2.9 kg
24925300	FA gully top E 250/250, fixed construction height	stainless steel	50	1.9 kg
24925301	FA gully top E 250/250, variable construction height	stainless steel	70 – 100	2.6 kg
24925302	FA gully top E 250/250, variable construction height	stainless steel	100 – 160	2.9 kg
24940200	FA gully top V 400/400, fixed construction height	galvanized steel	50	2.4 kg
24940201	FA gully top V 400/400, variable construction height	galvanized steel	70 – 100	3.3 kg
24940202	FA gully top V 400/400, variable construction height	galvanized steel	100 – 160	4.1 kg
24940300	FA gully top E 400/400, fixed construction height	stainless steel	50	2.4 kg
24940301	FA gully top E 400/400, variable construction height	stainless steel	70 – 100	3.3 kg
24940302	FA gully top E 400/400, variable construction height	stainless steel	100 – 160	4.1 kg
24925210	FA add-on frame for gully top V 250/250, fixed construction height	galvanized steel	80	1.5 kg
24940210	FA add-on frame for gully top V 400/400, fixed construction height	galvanized steel	80	3.3 kg
24925310	FA add-on frame for gully top E 250/250, fixed construction height	stainless steel	80	1.5 kg
24940310	FA add-on frame for gully top E 400/400, fixed construction height	stainless steel	80	3.3 kg
Item no.	Gratings for gully tops	Material	Pcs./Pallet	Weight
23500203	FA mesh grating, 150/150/20, MW 30/10	galvanized steel	120	0.7 kg
23500201	FA mesh grating, 200/200/20, MW 30/10	galvanized steel	120	1.1 kg
24525200	FA mesh grating, 240/240/20, MW 30/10	galvanized steel	120	1.3 kg
24525300	FA mesh grating, 240/240/20, MW 30/10	stainless steel	120	1.3 kg
24540200	FA mesh grating, 392/392/20, MW 30/10	galvanized steel	120	2.6 kg
24540300	FA mesh grating, 392/392/20, MW 30/10	stainless steel	120	2.6 kg

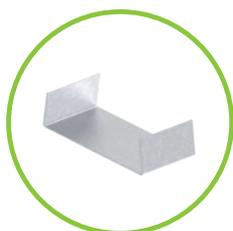

FA connection sleeve



FA outlet unit with outlet pipe

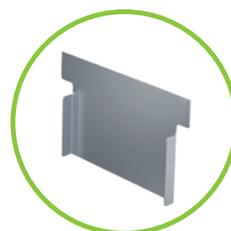

FA front caps



FA locking bar and pan head screw

BG-FLEX soffit drain element DN 100

for BG-FLEX FA facade channel

Item no.	Accessories - BG-FLEX range	Material	Weight	Pcs./Pallet
23900226	BG-FLEX soffit drain element DN 100, material thickness 1 mm variable length (extendable from 300 – 500 mm), outlet DN 100	galvanised steel	1,5 kg	40



BG-FLEX FA gravel stop

Item no.	gravel stop – perforated	Material	Length mm	Weight
23900911	FA gravel stop, 60 x 40 mm, 2 mm thickness	aluminium	2000	0,9 kg
24900702	FA gravel stop, 80 x 50 mm, 2 mm thickness	aluminium	2000	1,3 kg
23900922	FA gravel stop, 80 x 80 mm, 2 mm thickness	aluminium	2000	1,5 kg
23900912	FA gravel stop 100 x 80 mm, 2 mm thickness	aluminium	2000	1,7 kg
23900916	FA gravel stop, 100 x 80 mm, with additional fold, 1,5 mm thickness	aluminium	2000	1,5 kg
23900924	FA gravel stop, 150 x 100 mm, 2 mm thickness	aluminium	2000	2,3 kg

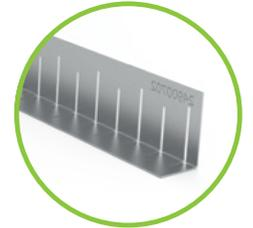

FA gravel stop

BG-FLEX FA height adjustment for facade channels

Item no.	adjustable foot	Material	Height mm	Weight
24900201	Additional charge for height adjustment press nuts per 1 m section	galvanised		0,1 kg
24900202	Additional charge for height adjustment press nuts per 2 m section	galvanised		0,1 kg
24900301	Additional charge for height adjustment press nuts per 1 m section	stainless steel		0,1 kg
24900302	Additional charge for height adjustment press nuts per 2 m section	stainless steel		0,1 kg
24900203	FA adjustable foot M 10 X 30	L galvanised	30	0,1 kg
24900204	FA adjustable foot M 10 X 40	L galvanised	40	0,1 kg
24900205	FA adjustable foot M 10 X 50	L galvanised	50	0,1 kg
24900208	FA adjustable foot M 10 X 80	L galvanised	80	0,1 kg
24900303	FA adjustable foot M 10 X 30	L stainless steel	30	0,1 kg
24900304	FA adjustable foot M 10 X 40	L stainless steel	40	0,1 kg
24900305	FA adjustable foot M 10 X 50	L stainless steel	50	0,1 kg
24900308	FA adjustable foot M 10 X 80	L stainless steel	80	0,1 kg



FA adjustable foot M 10, galvanised



Please note that, for height-adjustable facade channels, the 1-metre channel requires 4 adjustable feet and the 2-metre channel 6 adjustable feet in the corresponding height.

BG-FLEX FA branch channels

to connect channels and outlet

Item no.	Branch channels	Length mm	Height mm	Weight
37851	FA branch channel, 1000/90/30, galvanised	L 1000	30	1,1 kg
37852	FA branch channel, 2000/90/30, galvanised	L 2000	30	2,2 kg
37861	FA branch channel, 1000/90/30, stainless steel	L 1000	30	1,1 kg
37862	FA branch channel, 2000/90/30, stainless steel	L 2000	30	2,2 kg

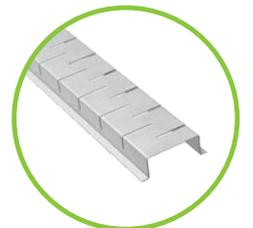

FA branch channels

BG-FLEX FA Terrace point drainage

height-adjustable point drainage unit for roof terraces and balconies

Item no.	Terrace point drainage units	Length/Width in mm	Height mm	Weight
23910701	Terrace point drainage incl. slotted grating, aluminium	200	38-128	1,3 kg
23910702	Terrace point drainage incl. slotted grating with hole for inlet, DM 70, aluminium	200	38-128	1,3 kg
23910703	Terrace point drainage incl. slotted grating with hole for inlet, DM 100, aluminium	200	38-128	1,3 kg
23910706	Drainage tray flat, galvanised and blasted, outlet DN 100	200	40	0,5 kg



Terrace point drainage



BG-FLEX^{TE}

Terrace slot channel

BG-FLEX^{TE} terrace slot channel, SW 18 mm / 1" – STAINLESS STEEL

for the drainage of terraces and gardens

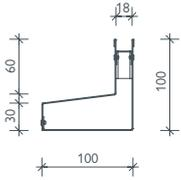

Fixed construction height

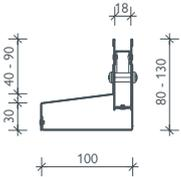

Variable construction height

Item no.	Channel body asymmetric – material thickness 1.00 mm	Length mm	Height mm	Weight
38000	TE E SW 18 – closed	1000	100	3.0 kg
38010	TE E SW 18 – closed	1000	80 – 130	3.7 kg
38020	TE E SW 18 – perforated	1000	100	3.0 kg
38030	TE E SW 18 – perforated	1000	80 – 130	3.7 kg
Item no.	Gratings	Material	Pcs./Pallet	Weight
37955	TE slot inlay with square perforation 8/8 mm, L = 500 mm	stainless steel	200	0.1 kg
37956	TE slot inlay with square perforation 8/8 mm, L = 1000 mm	stainless steel	100	0.2 kg
Item no.	Accessories	Material	Height mm	Weight
38040	TE maintenance unit 500/100 with lateral or bottom outlet	stainless steel	80 – 130	3.0 kg
13399	TE opening tool for maintenance unit-cover – 2 pcs. required	plastic/galv. steel		0.1 kg
38050	TE external corner 200/200 – non-perforated	stainless steel	80 – 130	1.2 kg
38055	TE internal corner 200/200 – non-perforated	stainless steel	80 – 130	1.4 kg
38060	TE front cap left/right, width 100 mm	stainless steel	80 – 130	0.1 kg



TE slot inlay with square perforation 8/8 mm

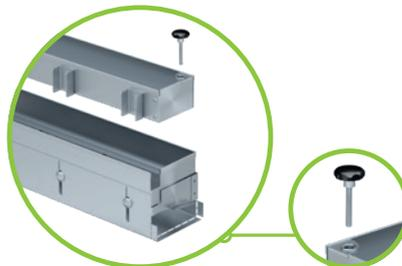

TE maintenance unit 500/100 with outlet: bottom DN 75 / at the side DN 50

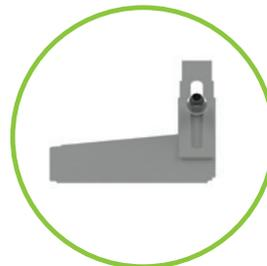

TE front cap left/right, width 100 mm

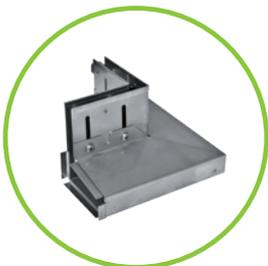

TE external corner 200/200 – non-perforated



TE internal corner 200/200, non-perforated

i Please note that delivery times may be longer for these product groups!



BG-FLEX™ terrace channel

BG-FLEX™ TM terrace channel, width 60 mm / 2" – STAINLESS STEEL

for drainage of paving on terraces and balconies

Item no.	Channel body	Length mm	Height mm	Weight
21106321	TM terrace channel with anchor plate	1000	30	2.1 kg
Item no.	Outlet unit	Length mm	Height mm	Weight
21106322	Outlet unit, outlet Ø 50 with anchor plate	1000	30	2.1 kg
21106331	SET, corner section	1000x1000	30	4.1 kg

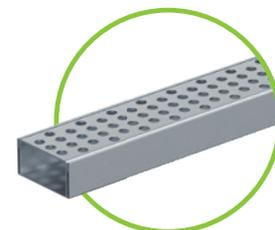

BG-FLEX™ TM terrace channel, width 60 mm / 2", LINEAR – STAINLESS STEEL

for drainage of paving on terraces and balconies

Item no.	Channel body	Length mm	Height mm	Weight
21106325	TM terrace channel LINEAR with anchor plate	1000	30	2.0 kg
Item no.	Outlet unit	Length mm	Height mm	Weight
21106326	Outlet unit, outlet Ø 50 with anchor plate	1000	30	2.1 kg
21106332	SET, corner section	1000x1000	30	4.0 kg



Advantages of the new mini channel for terrace:

- Material thicknesses: Channel body 0.75 mm / cover 1.50 mm
- narrow, discreet look through channel width 60
- Installation simultaneously with the paving stones on the surface, no special substructure is required
- A film on the channel grating provides protection against damage while construction is ongoing
- DIY due to quick-and-easy installation

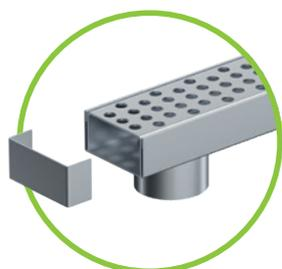
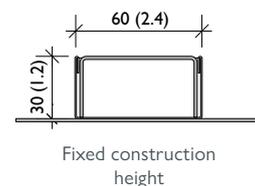

outlet unit incl. grating and front cap and connecting cap, bottom outlet DN 50



Outlet unit LINEAR incl. front cap/connecting cap, bottom outlet DN 50



SET, corner section



SET, corner section LINEAR

References

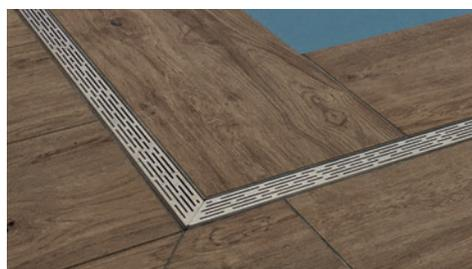



BG-FLEX stone terrace channel

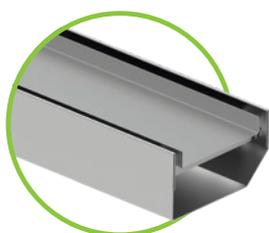

BG-FLEX stone made of stainless steel

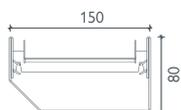

BG-FLEX stone, width 150 mm / 6" – STAINLESS STEEL

Non-perforated channel body made from 1.4301 stainless steel, incl. support bracket and stone basin; matching stone thickness 20 and 30 mm

Item no.	Channel body	Length	Height	Weight
21115301	stone E, width 150, incl. crossbar and stone basin	1000	80	5.8 kg
21115302	stone E, width 150, incl. crossbar and stone basin	2000	80	11.6 kg
Item no.	Accessories	Length	Height	Weight
21115303	stone E, width 150, incl. support bar and stone trough with outlet Ø 100	1000	80	6.2 kg
24915326	Coupling sleeve for stone, width 150	50	46	0.1 kg
24915327	front cap stone, width 150	15	80	0.1 kg



Delivery time on request.

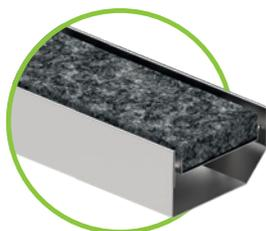

BG-FLEX stone made of stainless steel
Representative image: with granite, dark ¹⁾

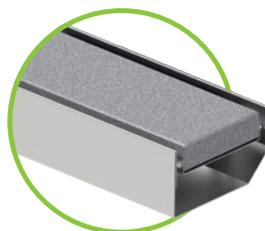

BG-FLEX stone made of stainless steel
Representative image: with granite, light ¹⁾

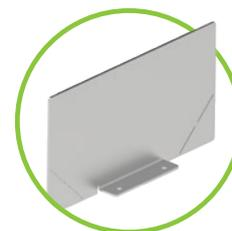

front cap BG-FLEX stone

References

BG-FILCOTEN®

BG-FLEX



As **unique** as your requirements.

Our special solutions.

We know that some challenges cannot be solved with standard channel elements. Our technicians will be happy to design special components or individual solutions for your requirements. With our know-how, we will produce what you need, and provide support on site.

Send us your project!

Our technical support will be happy to advise you and provide you with an overall quote for your project.



FA facade channel – adapted to the building



Slot tops for fountains / segment arches



FA facade channel – radial installation



TE terrace slot channel – curved



References



Slot top with drainage-slots for drainage of the second level



FA with mitred cut



FA with anti-slip mesh grating

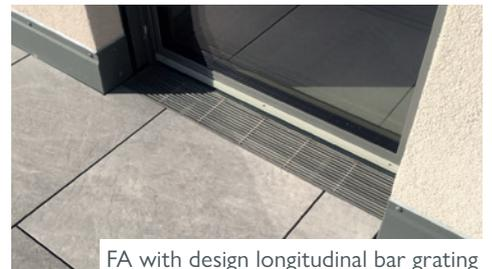

FA with design longitudinal bar grating

Understated yet remarkably efficient & resilient:

Indoor slot channel system BG-FLEX omega

The ability to withstand heavy loads without a cover and, at the same time, ensure reliable and long-lasting drainage performance, makes the BG-FLEX omega slotted channel a simple, economical solution for your indoor drainage.

Thanks to the "V"-shaped channel bottom, liquids can be drained off safely and efficiently. An integrated odour trap is included in outlet units as standard.

Areas of application.

Food industry, industrial kitchens, slaughterhouses, wineries, breweries, etc.

up to class C 250

Visible edge with shimming

- Made of PVC, adhered in the edge
- for cavity-free, high load capacity grouting in the concrete/in the coating

Liquid-tight joints

- Bolted flange
- seal made from EPDM (alternatively made from Teflon or silicone)
- Complete with stainless steel bolting M 8

Corner piece

- Corner piece with leg length of 500 mm low cost and efficient corner solution
- Outstanding in traffic areas

Outlet elements incl. odour trap

- Outlet unit with horizontal outlet or vertical outlet (see outlet element above)
- various dimensions and heights for higher drainage capacity
- removable silt bucket
- solid cover navigable up to B 125, Class C 250 on request



Channel body made from stainless steel

- optimised omega shape for high drainage performance, easy cleaning and high stability (inbuilt slot bridge)
- Stainless steel 1.4301 or higher quality upon request
- Material thickness: 2 mm
- Slot width of 16 mm, no cover required

Connecting elements

- For corner, cross and T-connections
- also available with outlet

Channel with outlet

- vertical/horizontal outlet directly from the channel element
- freely chosen position in the channel run

Anchor plate

- permanent fixing in the adjacent floor construction

Elevation

- height-adjustable elevated rack as a complete set

Front / end cap

- Tightly welded
- for tidy and leak-proof closure of the channel run

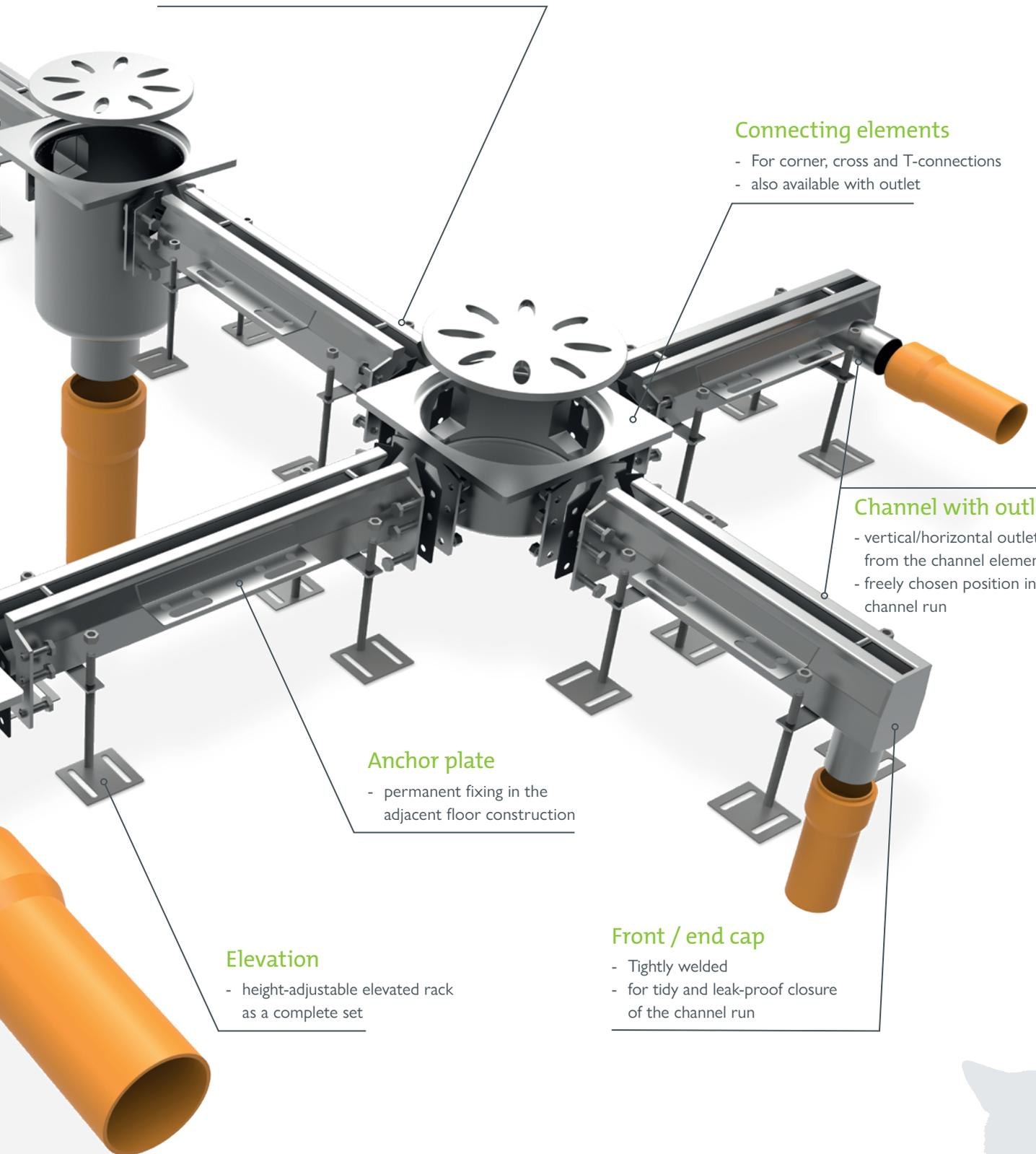

up to class C 250

BG-FLEX omega

Indoor slot channel system



BG-FLEX omega SW 16 mm / 0,5" – STAINLESS STEEL

Channel elements with or without slope, with sealing flange for bolting

omega without slope – material thickness: 2.0 mm	Length mm	Height mm	Weight
omega – SW 16, without slope, various heights – flange at both ends	to max. 3000	65 – 200	4.4 – 25.5 kg
omega with 0,5 % slope – material thickness: 2.0 mm	Length mm	Height mm	Weight
omega – SW 16, with 0.5 % slope, different construction heights – flange on both sides	to max. 3000	65 – 200	4.5 – 24.6 kg

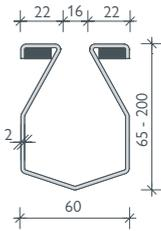

with seal

BG-FLEX omega outlet element incl. odour trap

for BG-FLEX omega slotted channels, with silt bucket, in various sizes and heights, for vertical or horizontal connection

omega outlet units incl. odour trap and silt bucket	Material	Height mm	Weight
omega outlet element 247 x 247 with silt trap, with outlet Ø 100, for vertical connection	stainless steel	260	8.3 kg
omega outlet element 247 x 247 with sediment bucket, with Ø 100 outlet, for horizontal connection	stainless steel	260	8.3 kg



Other outlet units for higher hydraulic capacity available upon request.



omega outlet elements incl. odour trap and silt trap, horizontal outlet



omega outlet elements including odour trap and sediment bucket vertical outlet



Please note that these products are manufactured to order – they are not stock products!



GRASPOINTNER
Sustainable innovation.

Accessories

for BG-FLEX omega slotted channels, SW 16 mm / 0,5"

Accessories	Material	Height mm	Weight
omega corner 90°, leg length 500 mm	stainless steel	65 – 200	4.4 – 9.0 kg
omega corner connector 90°	stainless steel	65 – 200	5.7 – 7.3 kg
omega T-connector	stainless steel	65 – 200	6.1 – 7.8 kg
omega cross connector	stainless steel	65 – 200	6.5 – 8.3 kg
omega front or end cap	stainless steel	65 – 200	0.3 – 2.7 kg
omega end cap with outlet Ø 50 mm	stainless steel	65 – 200	0.4 – 2.8 kg



omega corner with leg length 500 mm

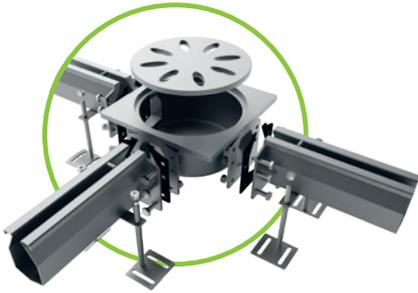

omega corner connector

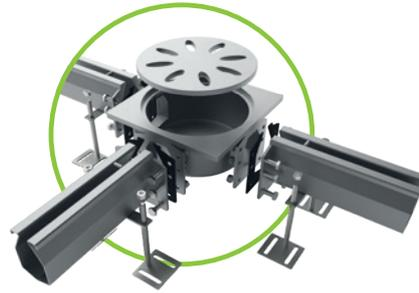

omega T-connector

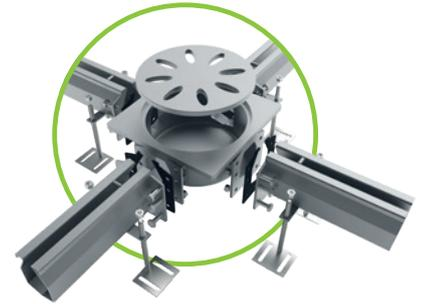

omega cross connector

Send us your project!

Our technical support will be happy to advise you and provide you with a quote for your project.

CA: technical@bg-graspointner.com

USA: sales.usa@bg-graspointner.com



References



Coated concrete has a new best friend ...

Drainage channel system BG-FLEX sigma tec

BG-FLEX sigma tec, the drainage system for commercial buildings, is made of stainless steel 1.4301 or a higher grade. The product is the ideal solution for draining accumulating surface water from coated concrete surface coverings. Floor coatings can be laid so they are snug with the channel system for the long-lasting protection of the building structure.

Gratings of stainless steel or plastic, depending on the nominal width, can be selected from the BG-FILCOTEN® product range, up to load class C 250.

Areas of application.

Car parks, parking areas, food processing sites, chemical plants, breweries, dairies, supermarkets, catering, hospitals, etc.

up to class C 250

Liquid-tight joints

- Bolted flange
- NBR seal
- complete with stainless steel bolting M 6

front cap

- for a clean finish to the channel run
- Incl. surface strip
- With bolted seal

Perforated coating slot

- permanently connects the floor coating to the perforated slot connection plate

Elevation

- height-adjustable elevated rack as a complete set



Gratings

- COMBee plastic design-grating or mesh grating made from stainless steel
- Hole size 7 mm or MW 30/10
- Load class B 125 or C 250
- with fiX-locking
- bolting available at extra cost

Sump pit frame

- As connecting element
- also for T, corner and cross connections as stacking frame for a catch basin/sump pit constructed on site

Anchor bar

- for permanent fixing of the channel body in the adjacent floor structure

Channel body

- from stainless steel or higher quality
- Nominal width: 100 mm
visible width: 125 mm
- Element length: 2000 mm
(adjustable to the line length)
- Material thickness: 1,5 mm

Outlet units

- outlet pipe with diameter DN 100
- individual placement in the channel run
- outlet as feed line
e.g. to the oil separator

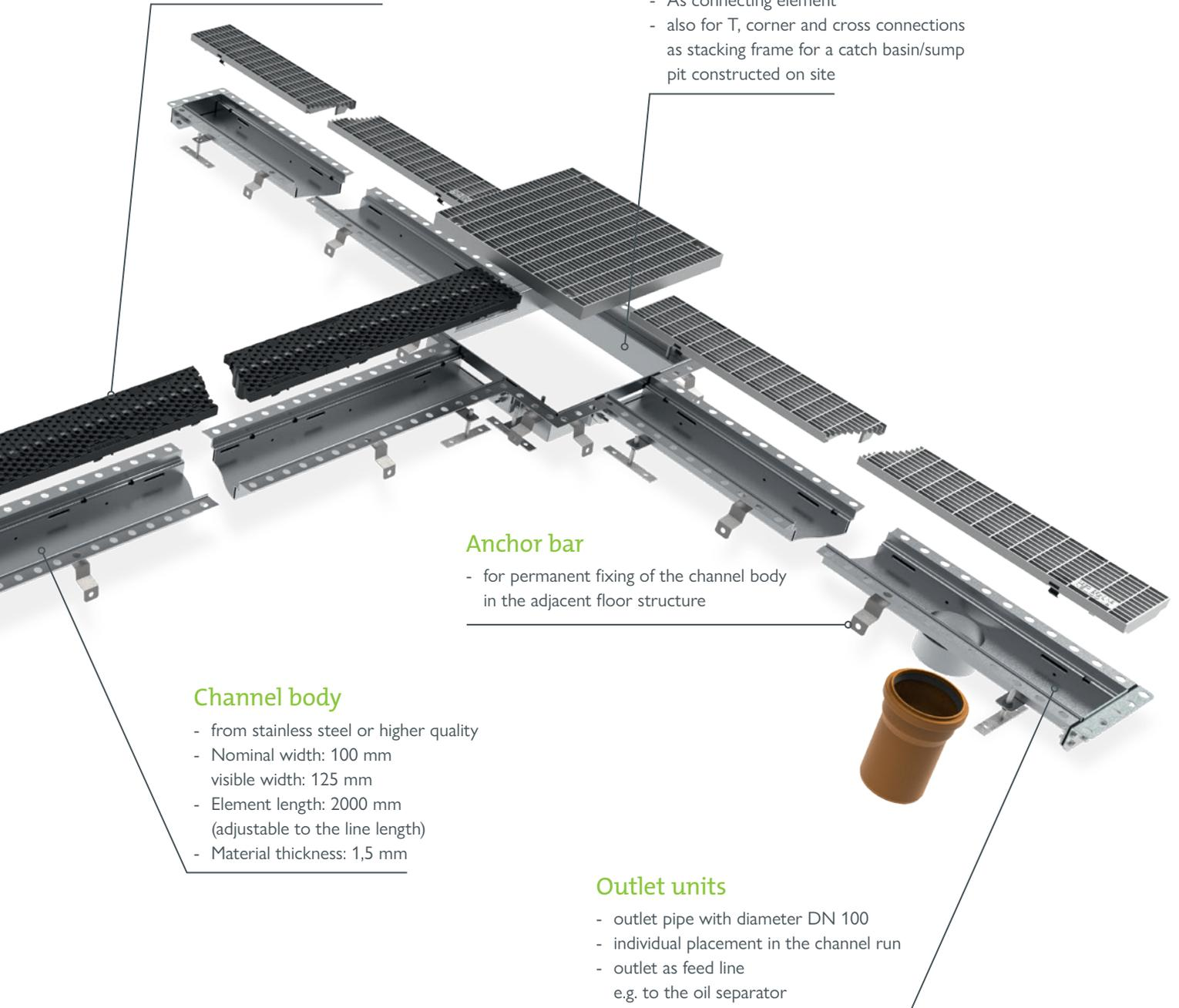

up to class C 250

BG-FLEX sigma tec

Drainage channel system



BG-FLEX sigma tec, nominal width 100 mm / 4" – STAINLESS STEEL

Channel elements without slope, with sealing flange Incl. elevated stand, seal and bolted butt joint; visible width 125 mm, internal height 50 mm

Item no.	sigma tec without slope – material thickness: 1.5 mm	Length mm	Height mm	Weight
20710351	Standard element	2000	72	10.2 kg
20710352	Channel element	500	72	3.3 kg
20710353	Channel element	1000	72	5.6 kg
20710354	Channel element	1500	72	8.5 kg
20710355	fitting piece	on request	72	

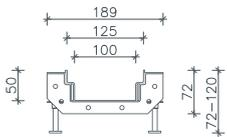

BG-FLEX sigma tec outlet elements

Sump pit frame, can be placed anywhere in the channel run, as a connecting, end, T or cross element



Item no.	sigma tec outlet elements, material thickness 1.5 mm	Length mm	Height mm	Weight
20710361	channel element NW 100, with outlet Ø 100	500	72	3.8 kg
Item no.	Sump pit frame, material thickness 1.5 mm	Material	Height mm	Weight
20700301	Mesh grating, sump pit frame, 400/400/30, MW 30/10	B 125		
20700302	Mesh grating, sump pit frame, 400/400/30, MW 30/10	C 250		
20710371	End piece 400/400	stainless steel	100	4.5 kg
20710372	Straight connection piece	stainless steel	100	4.0 kg
20710373	Corner piece 90° 400/400	stainless steel	100	4.0 kg
20710374	T-piece 400/400	stainless steel	100	4.5 kg
20710375	Cross piece 400/400	stainless steel	100	4.5 kg
Item no.	Covers, material thickness 1.5mm	Load class	Height mm	Weight
20700301	Mesh grating for sump pit frame MW 30/10	class B 125	30	10.0 kg
20700302	Mesh grating for sump pit frame MW 30/10	class C 250	30	11.8 kg

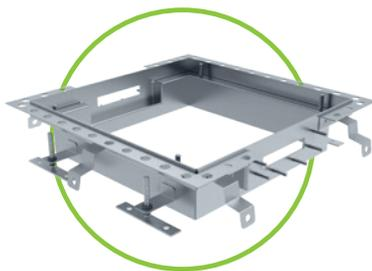

sigma tec
Sump pit frame



sigma tec
Sump pit frame
with mesh grating

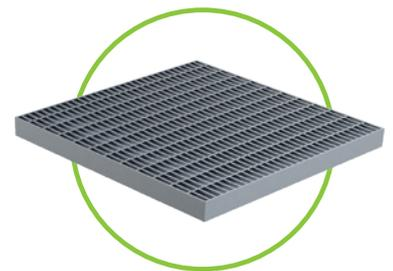

Mesh grating MW 30/10, stainless steel



Please note that these products are manufactured to order – they are not stock products!



Gratings and accessories

for BG-FLEX sigma tec drainage channels, nominal width 100 mm / 4"

Item no.	Gratings with fiX-locking	Load class	Height mm	Weight
17010322	mesh grating 1000/122/20, MW 30/10, stainless steel	C 250	20	3.3 kg
17010401	COMBee design grating 500/123/20, Ø 7.3 mm, plastic PA6	B 125	20	0.9 kg
17010402	COMBee design grating 500/123/20, Ø 7.3 mm, plastic PA6	C 250	20	1.1 kg
17010403	COMTread slotted grating 500/123/20, SW 8/40, plastic PA6	B 125	20	0.9 kg
Item no.	Accessories		Material	Weight
20710317	front cap NW100, incl. seal & bolts		stainless steel	0.6 kg
Base outlet 150x150 mm material thickness: 3mm, outlet nozzles Ø 100, incl. mesh grating			stainless steel	0.5 kg

NEW



mesh grating class C



COMBee design grating



COMTread slotted grating

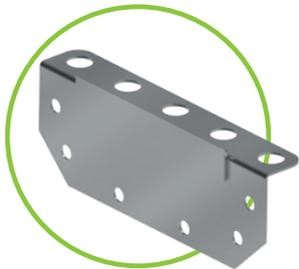

Front cap



Base outlet 150x150 mm

Send us your project!

Our technical support will be happy to advise you and provide you with a quote for your project.

CA: technical@bg-graspointner.com

USA: sales.usa@bg-graspointner.com



The gratings on the left are
beautiful & functional.
 On the right it's the **other way around.**

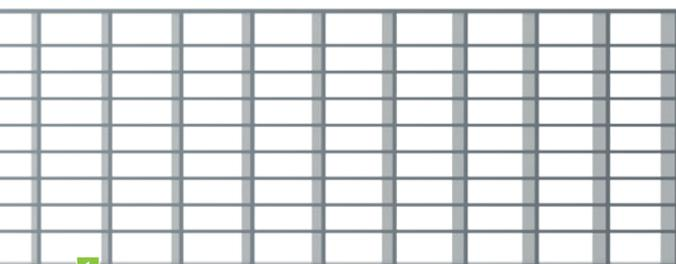
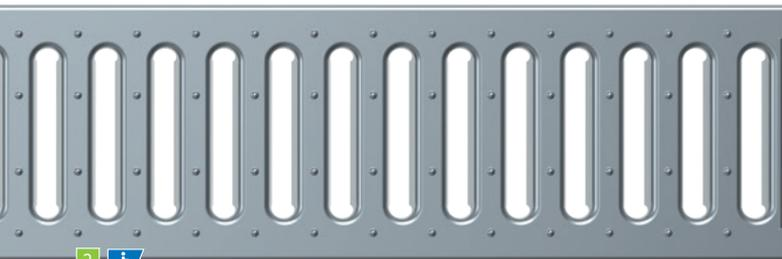
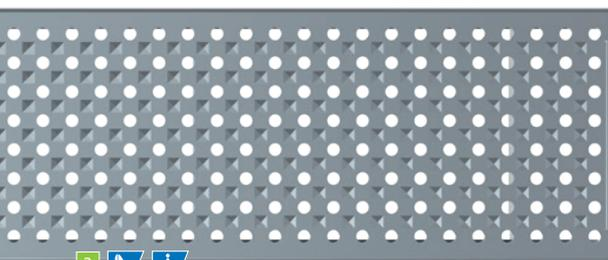

FA bolting-material set

BG-FLEX FA & FA glass

Gratings	SW, MW, Ø in mm	
1 Mesh grating ³⁾	MW 30/10	
2 Slotted grating	SW 9/80 SW 9/130	
3 Perforated grating	Ø 6	
4 longitudinal bar grating ³⁾	SW 10	
5 design-longitudinal bar grating	SW 6	

BG-FLEX TE

Gratings	SW, MW, Ø in mm	
6 slot inlay	MW 8/8	

BG-FLEX TM

Gratings	SW, MW, Ø in mm	
7 Perforated grating	Ø 6	
8 Linear grating	SW 5	

BG-FLEX sigma tec

Gratings	SW, MW, Ø in mm	
9 COMBee design grating	Ø 7.3	
10 COMTread slotted grating	SW 8/40	
11 Mesh grating	SW 30/10	

¹⁾ Classes according to EN 1433:
 A 15 kN | B 125 kN | C 250 kN
 D 400 kN | E 600 kN | F 900 kN

²⁾ Material:
 V: Galvanized steel | E: Stainless steel | PA6: Polyamide plastic

³⁾ FA bolting-material set
 Optional attachment with bolting-material set





4



5



6



Facade channels

	NW 100	NW 130	NW 150	NW 200	NW 250	Class ¹⁾	Material ²⁾
	✓	✓	✓	✓	✓	walkable	V, E
		✓				walkable	V, E
				✓		walkable	V, E
		✓		✓		walkable	V, E
	✓	✓	✓	✓		walkable	V, E
	✓	✓	✓	✓		walkable	E

Terrace slot channels

	NW 100	Class ¹⁾	Material ²⁾
	✓	walkable	E

Terrace channels

	NW 60	Class ¹⁾	Material ²⁾
	✓	walkable	E
	✓	walkable	E

Drainage channel system

	NW 100	Class ¹⁾	Material ²⁾
	✓	B, C	PA6
	✓	C	PA6
	✓	C	E

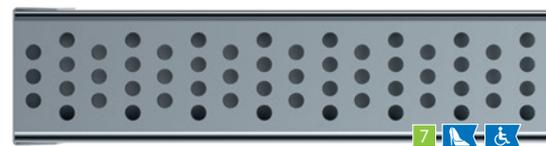

7



8



www.bg-graspointner.com

5 9 10 **BG-BLACK LABEL**
design line

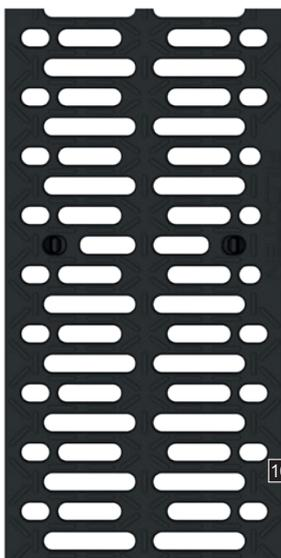

10



9

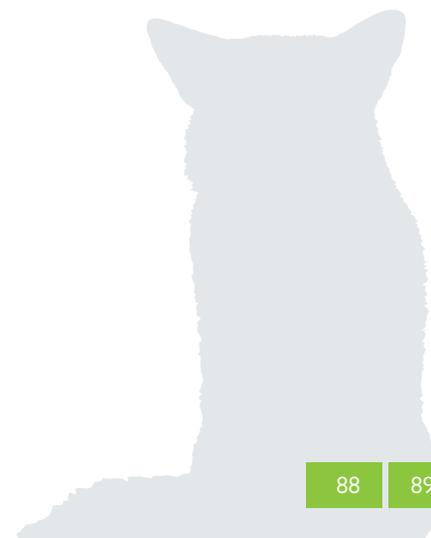



CITYGRID

Impact resistant Permeable Ground Grids made of 100% recycled/recyclable plastic – heavy duty

Item no.	Impact resistant Permeable Ground Grids	L/W/H	Weight	Pc./pallet
80090401	CITYGRID, Heavy duty permeable ground grid, 0.6/0.4/0.08m (24/15.75/3.15 in), tongue and groove connection, plastic	"60/40/8 mm 24/15.75/3.15 in"	9.0 kg / 19.8 lb	135

Permeable design

A rigid but open cellular design allows the grids to provide both exceptional support and water management.

Lightweight

Complies with HSE manual handling guidelines.

Flexible

Polymer construction is semi flexible and resistant to cracking unlike concrete.

High load

Meets high SLW vehicle usage specifications, up to 60 metric tonnes (DIN 1072).

Environmentally friendly

Manufactured from 100% recycled plastic.

Application options

Open cells can be filled with either gravel or soil and seed depending on your application.

Stable

Location fit connection improves stability once units are in position.

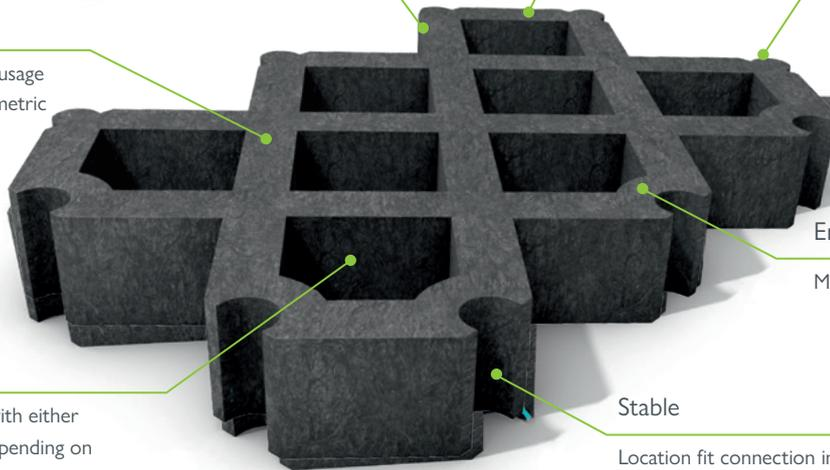

References



Typical installation example

Heavy duty permeable ground grid infiltration

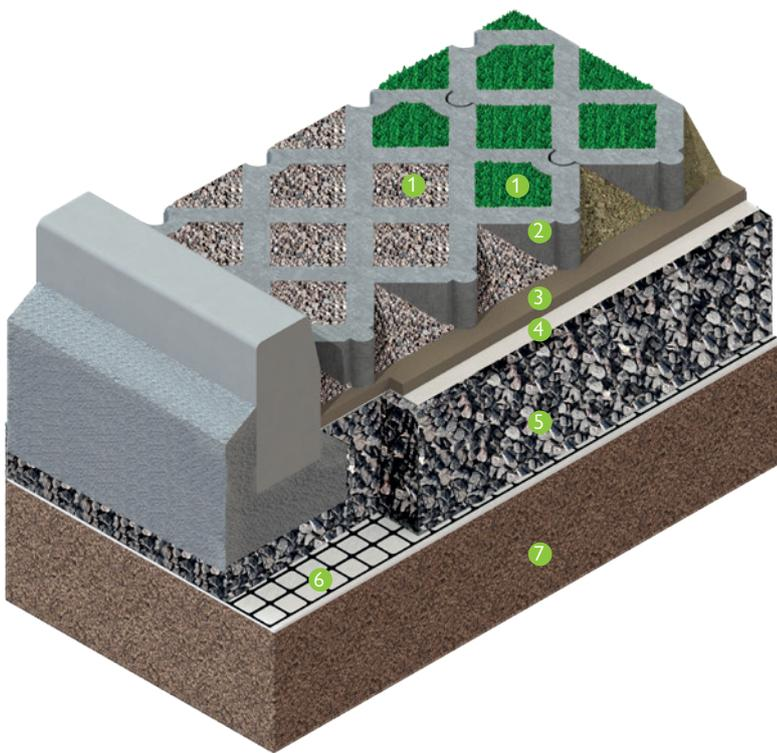

Key

- 1 Grass seeded or gravel finish
- 2 Citygrid units (permeable grid) Grass
Good quality, free-draining friable top soil, seeded at 6 - 10 lbs per 1,000 ft², pre-seeding fertilizer applied.
Gravel
Clean, free-draining angular crushed rock 0.2 - 0.6". Do not use rounded or river washed gravel.
- 3 Grit bedding
Clean coarse 0.08 - 0.25" grit compacted to 0.8".
- 4 Geotextile filtration layer
Non-woven needle-punched, minimum 3.25 oz/yd².
- 5 Free-draining engineered sub-base
Free-draining granular base with a depth to suit the anticipated loading. N.B. Standard granular base is not suitable as it's not free-draining.
- 6 Geotextile separation layer/Geogrid
30/30 geogrid on a non-woven needle-punched geotextile, minimum 3.25 oz/yd².
- 7 Sub soil
Establish CBR value to calculate depth of free-draining granular base.

Citygrid attenuation with gravel

A sealed geomembrane should be installed between the geotextile and the subgrade to prevent infiltration. Surface water should be directed to a suitable outlet.

Installation examples for BG-FILCOTEN® and BG-CLASSIC

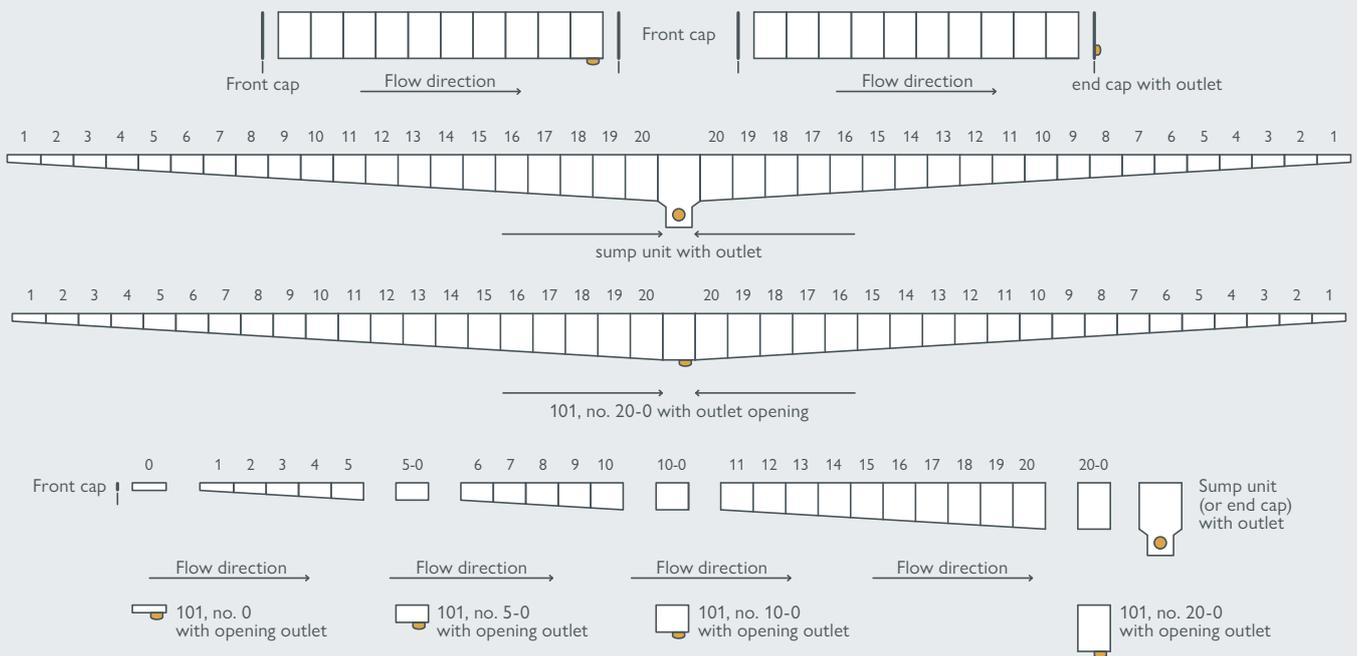



Installation of concrete channels without edges.

- resilient up to class C 250 kN
- paving stones or slabs can be laid directly next to the channel
- the grating's special construction ensures no concrete edges are visible (BG-FILCOTEN® light)
- separate gratings can be interlocked

CAUTION Starting, braking and torsional forces must be considered separately. Follow the installation instructions. Subject to technical modifications.

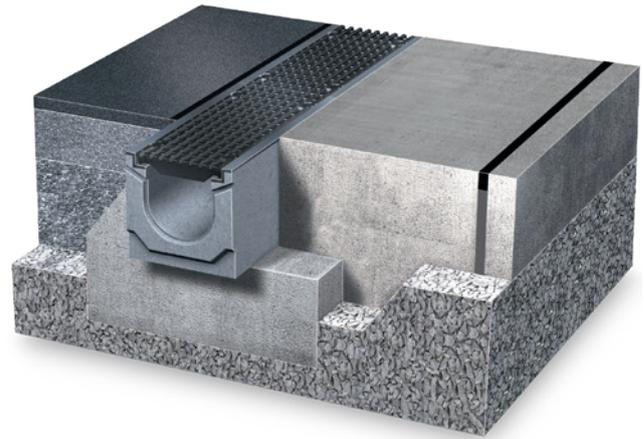

Installation of concrete channels with edges.

- resilient up to class F 900 kN – depends on channel model
- surrounding covering surfaces (asphalt, concrete) can be easily and neatly processed on the edges of frames
- if horizontal forces may occur (runway concrete), an expansion joint is to be installed at a distance of 30 – 150 cm
- gratings should primarily be bolted in place for load class D 400 kN and above



GRASPOINTNER
Sustainable innovation.

BG-Graspointner USA Inc.
134 Boynton Ave
Plattsburgh, NY 12901
USA

Phone: +1 518 299 1500

E-mail: sales.usa@bg-graspointner.com

Web: www.bg-graspointner.com

BG-Graspointner USA Inc.
134 Boynton Ave
Plattsburgh, NY 12901
USA

Phone: +1 518 299 1500

E-Mail: sales.usa@bg-graspointner.com

Web: www.bg-graspointner.com



Your partner for BG-Graspointner drainage systems.

