

Žľab/Channel:

FILCOTEN one NW150

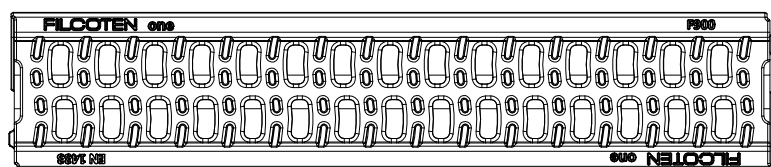
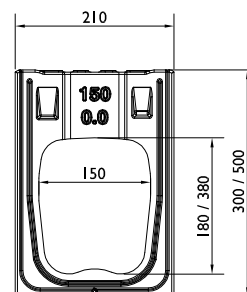
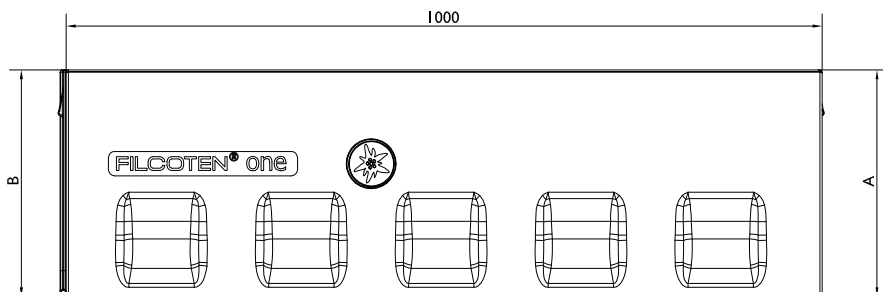

Žľab / channel - rozmery / dimensions [mm]						
BG code	Typ	výška A height A	výška B height B	dĺžka length	nátoková plocha [cm/m ²] inlet cross section [cm /m]	hmot. [kg] weight [kg]
15015100	0	300	300	1000	370	76,6
15015168	40-0	500	500	1000	370	107,5

Revízny kus / Maintenance unit

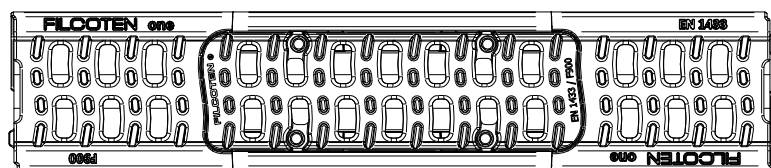
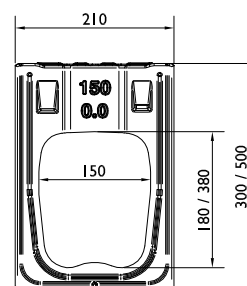
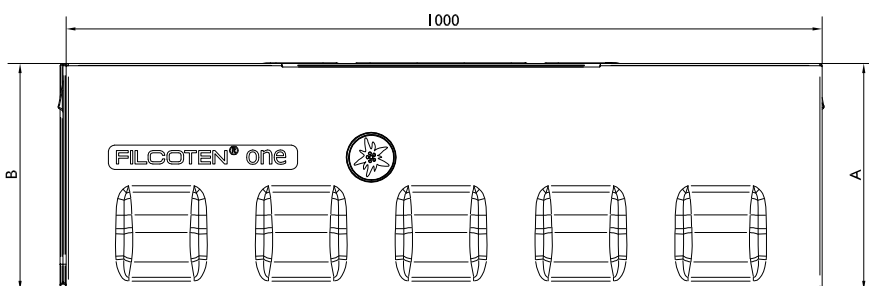

Revízny kus / Maintenance unit - rozmery / dimensions [mm]						
BG code	Typ	výška A height A	výška B height B	dĺžka length	hmotn. [kg] weight [kg]	
15015180	0	300	300	1000	79,5	
15015188	40-0	500	500	1000	108	

legenda / explanation:	
FCT:	FILCOTEN
E:	nerezová oceľ / stainless steel
V:	pozinkovaná oceľ / galvanized steel
G:	liatina / ductil iron
H:	drevo / wood

Rohový kus / Corner Unit

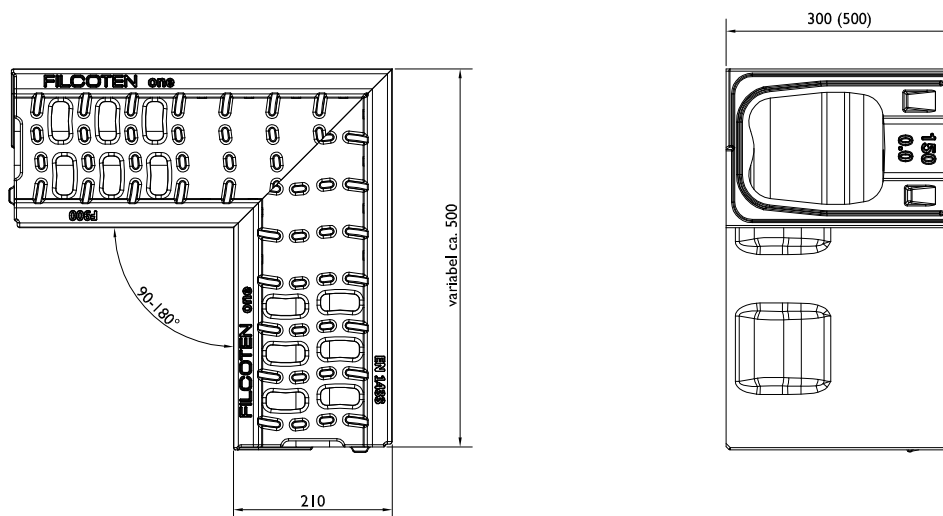

Rohový kus / Corner unit - rozmery / dimensions [mm]					
BG code	Typ	výška A height A	výška B height B	dĺžka length	hmotn. [kg] weight [kg]
I5015000	0	300	300	var.	ca. 80
I5015008	40-0	500	500	var.	ca.110

Odtokový kus / Outlet Unit with drilling

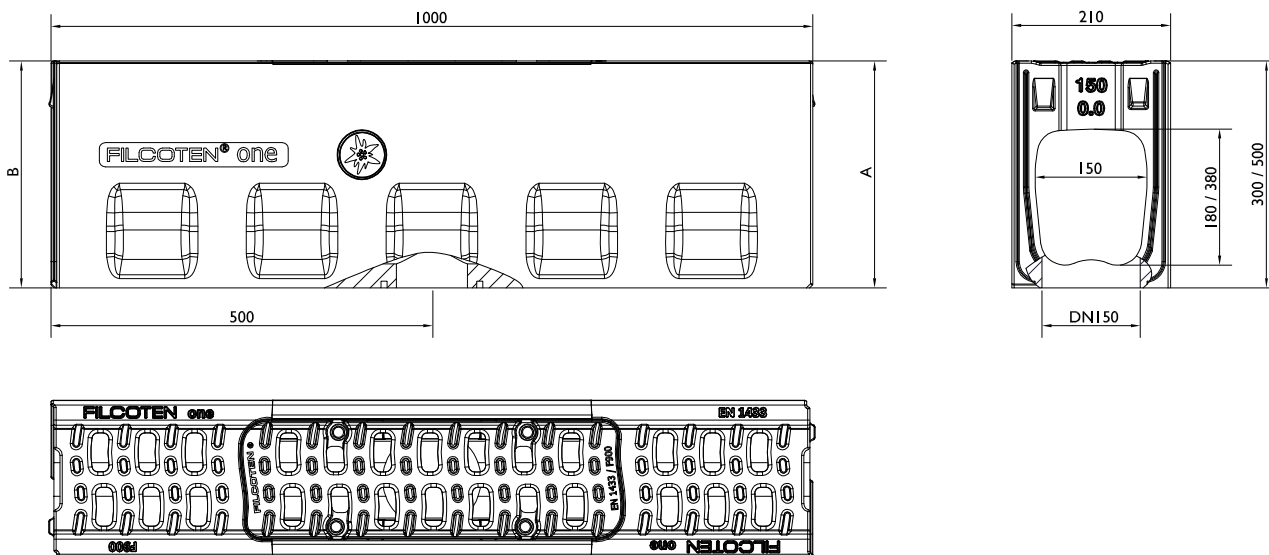

Odtokový kus / Outlet unit - Maße / dimensions [mm]					
BG code	Typ	výška A height A	výška B height B	dĺžka length	hmotn. [kg] weight [kg]
I5015190	0	300	300	1000	82
I5015198	40-0	500	500	1000	110

Vpust, vrchný diel / Outlet Unit

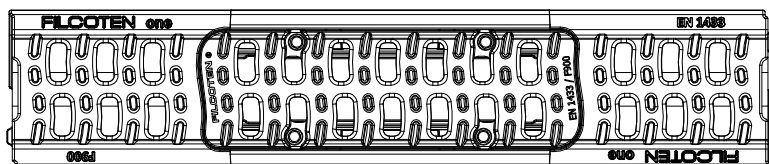
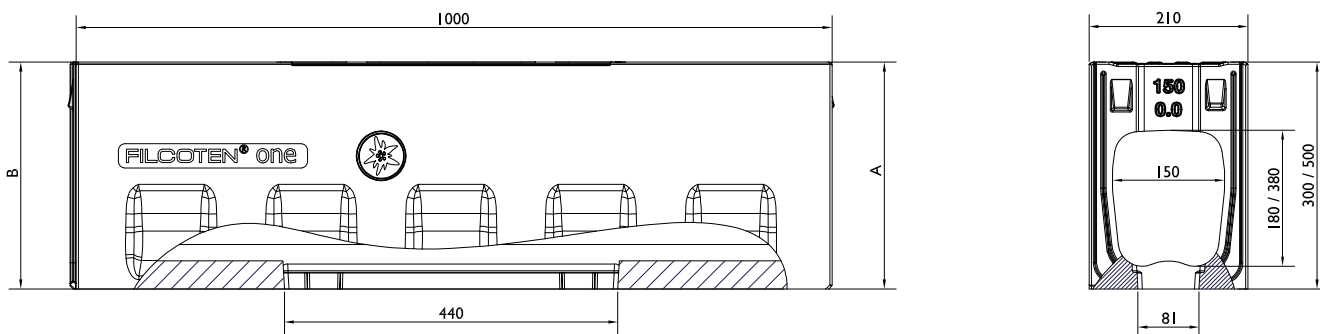

Vpust / Outlet unit - rozmery / dimensions [mm]					
BG code	Typ	výška A height A	výška B height B	dĺžka length	hmotn. [kg] weight [kg]
I5015170	0	300	300	1000	76,8
I5015178	40-0	500	500	1000	105,4

Klaový kôš / Silt bucket
(voliteľné pre vpust / for outlet unit)

BG code: 22510 (PVC); 0,5kg

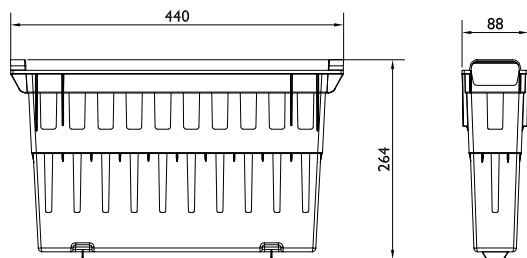

vpustový medzikus / middle part
BG code: FCT 19115094 28kg

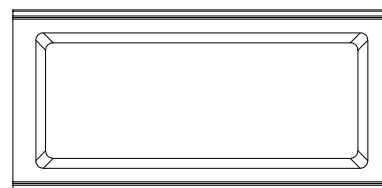
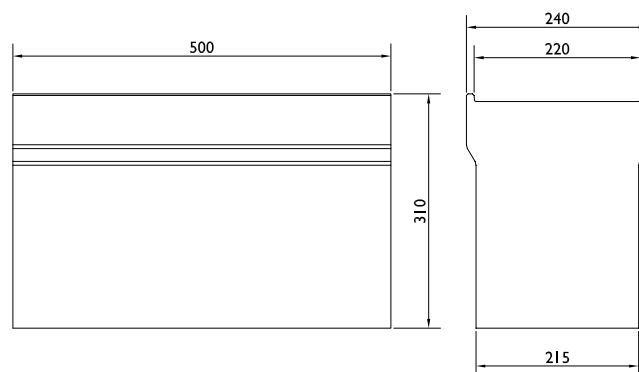

Vpust, spodný diel DN150 / Outlet-unit base-part DN150
BG code: 19115095; 32,8kg

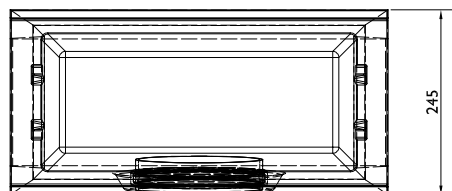
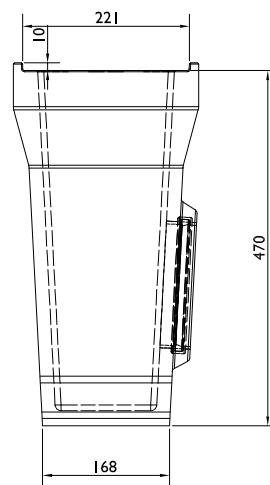
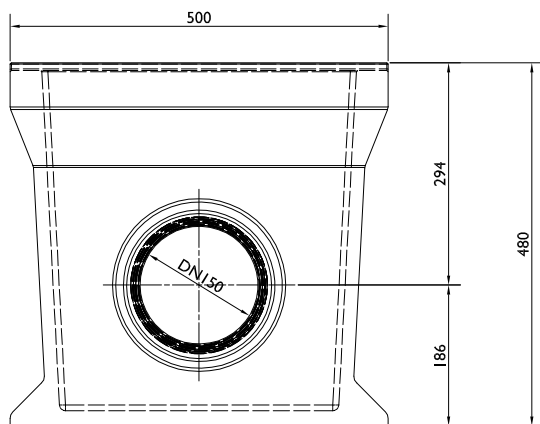

Vpust, spodný diel DN200 / Outlet-unit base-part DN200
BG code: 19115096; 33,3 kg

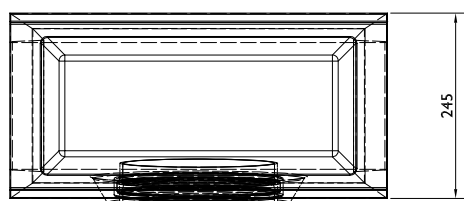
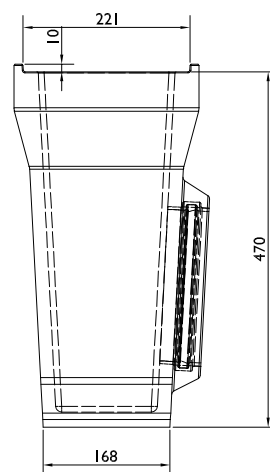
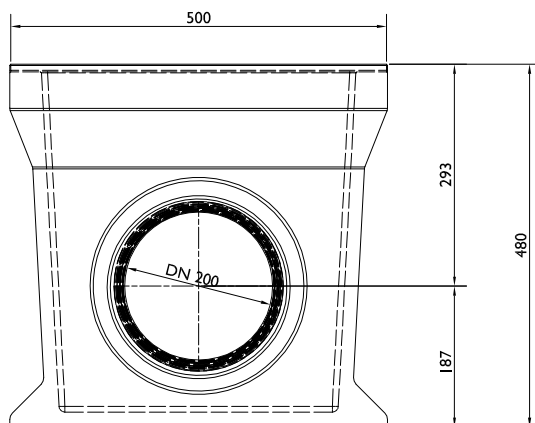

Zostava vpustového kusu s kalovým košom a odtokom DN150 /
Assembly outlet unit upper part, middle part and base part DN150

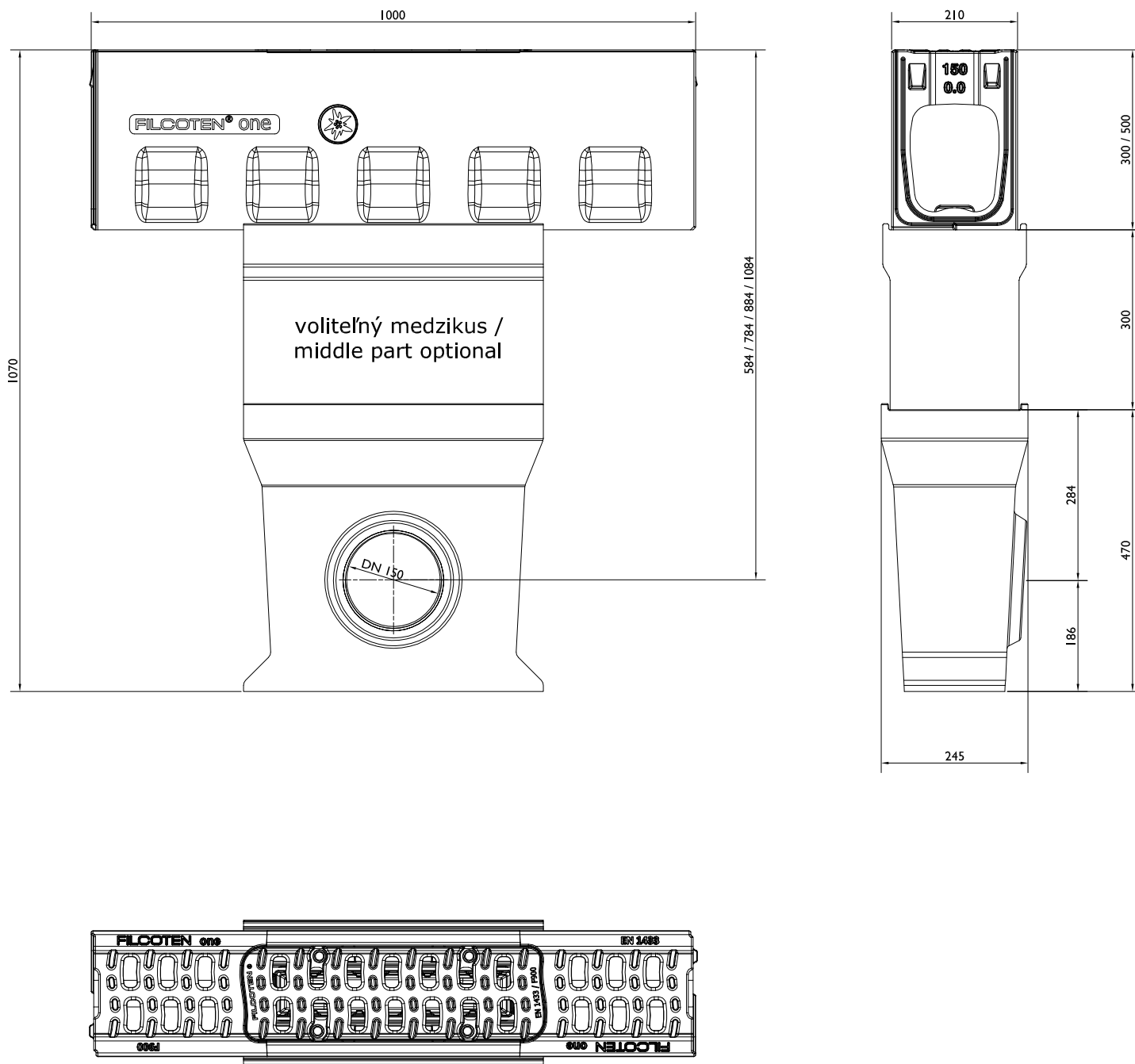

Koncové čelo (s odtokom) / Endplate (with outlet)

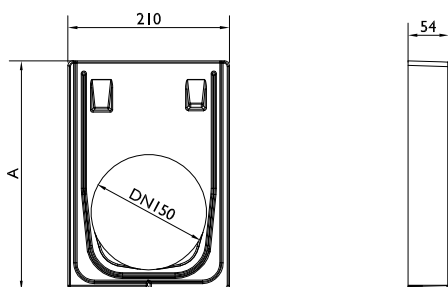

Koncové čelo (s odtokom) / Endplate (with outlet) - rozmery / dimensions [mm]				
BG code	Typ	výška A height A	dim. odtoku diameter	hmotn. [kg]
I9115110	0-0	300	150	5
I9115118	40-0	500	150	10

Koncové čelo (bez odtoku) / Frontplate (without outlet)

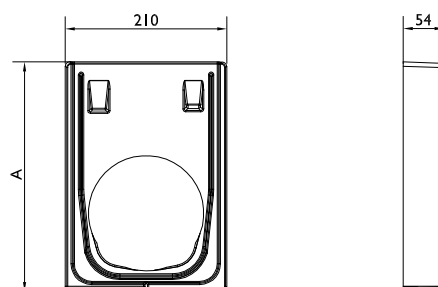

Koncové čelo (bez odtoku) / Frontplate (without outlet) - rozmery [mm]			
BG code	Typ	výška A height A	hmotn. [kg]
I9115100	0-0	300	7
I9115108	40-0	500	12

Spojovacia stena z č.0 do č.40-0 / Connectorplate for stepped fall Nr.0 / 0-40

BG code: I9115157; 9kg

pohľad / view A

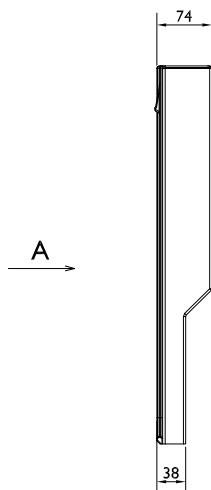
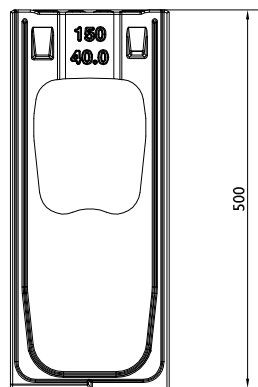

pohľad / view B

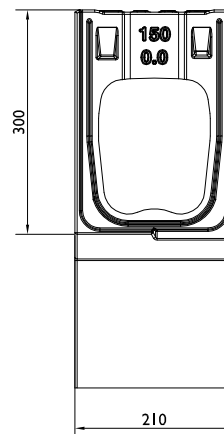

tesniaci profil / sealing-profile
(optional)

BG code	Typ	dĺžka length
I9115701	0-0	630
I9115702	40-0	1040

Zdvíhací hák / Verhabeheken
BG code: 19115900

