

Zusammenstellung / compilation:

NW100 5-0:

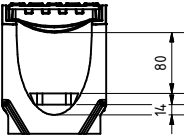

NW100 10-0:

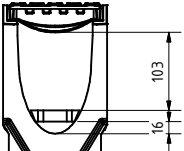

NW100 20-0:

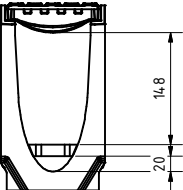

NW150 5-0:

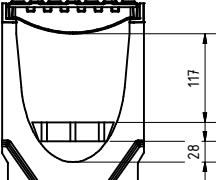

NW150 10-0:

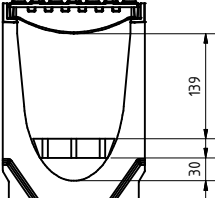

NW150 20-0:

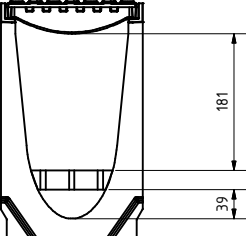

NW200 5-0:

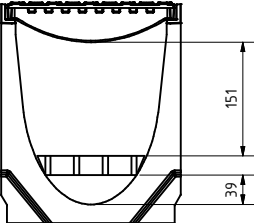

NW200 10-0:

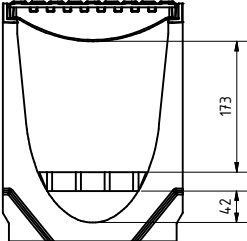

NW200 20-0:

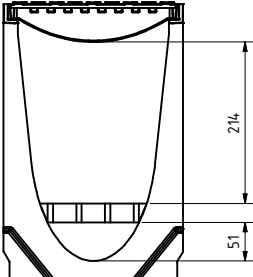

NW300 5-0:

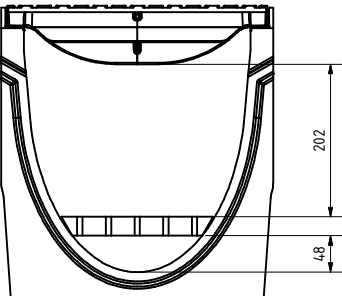

NW300 10-0:

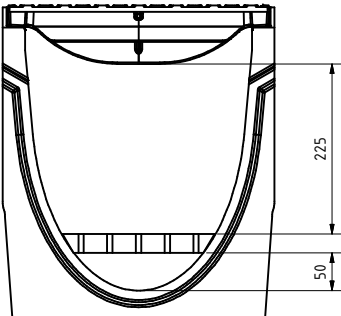

NW300 20-0:

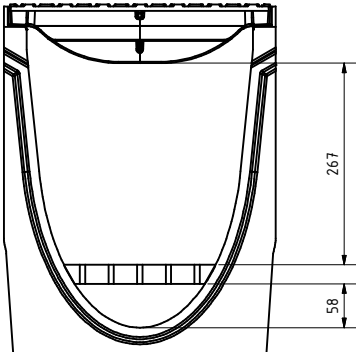

Medienkanäle / Media channels:

FCT connect: NW100, E600, Nr. 5-0, 10-0, 20-0  
 FCT connect: NW100, E600, No. 5-0, 10-0, 20-0  
 BG code: 10610161, 10610162, 10610164; 22,6 kg, 26,1 kg, 32 kg:

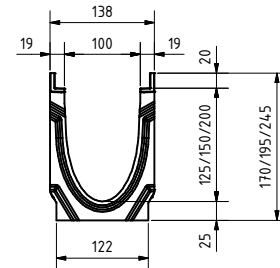
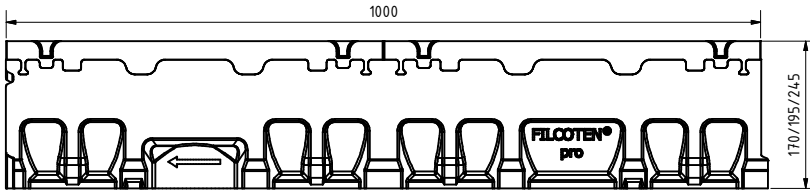

FCT connect: NW150, E600, Nr. 5-0, 10-0, 20-0  
 FCT connect: NW150, E600, No. 5-0, 10-0, 20-0  
 BG code: 10615161, 10615162, 10615164; 35,6 kg, 38,8 kg, 48,7 kg:

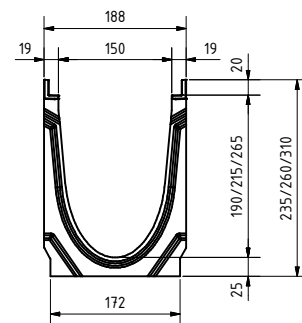
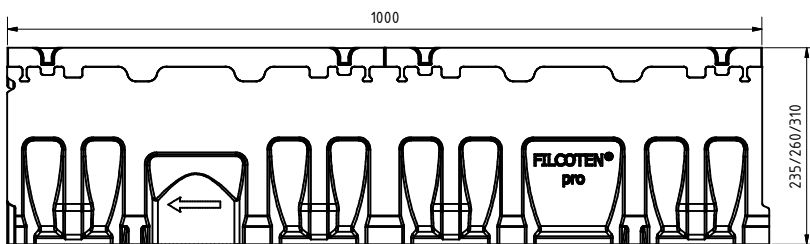

FCT connect: NW200, E600, Nr. 5-0, 10-0, 20-0  
 FCT connect: NW200, E600, No. 5-0, 10-0, 20-0  
 BG code: 10620161, 10620162, 10620164; 50,3 kg, 55,3 kg, 65,6 kg:

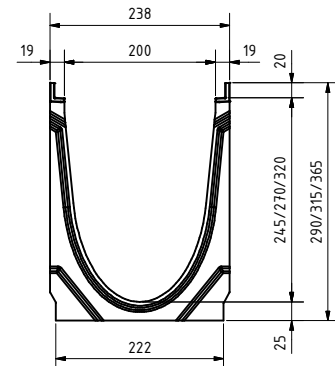
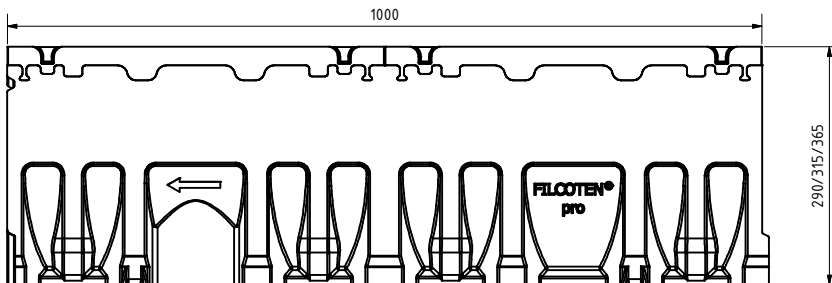

FCT connect: NW300, E600, Nr. 5-0, 10-0, 20-0  
 FCT connect: NW300, E600, No. 5-0, 10-0, 20-0  
 BG code: 10630161, 10630162, 10630164; 86,5 kg, 92,5 kg, 110,7 kg:

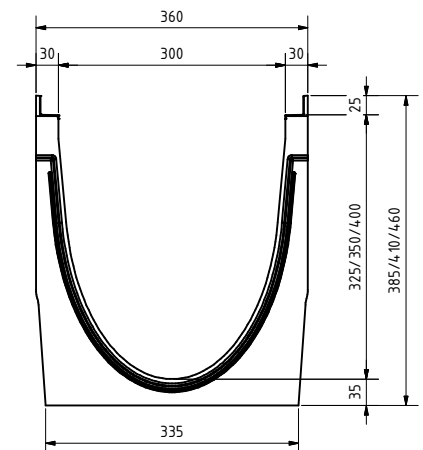
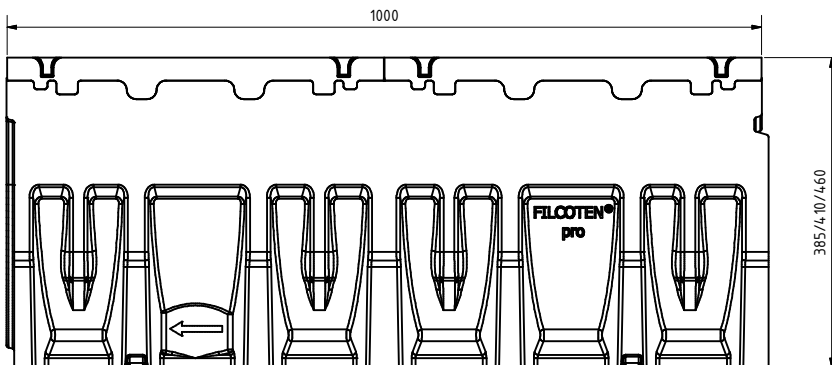

Legende / explanation:	
FCT:	FILCOTEN HPC
G:	Gußeisen / ductile iron

Abdeckungen / covers:

4-fach verschraubbar/4-times bolted

Guss-Abdeckung geschl. / ductile iron cover closed: NW100, E600  
BG code: 17010113; 5,3 kg:

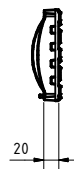
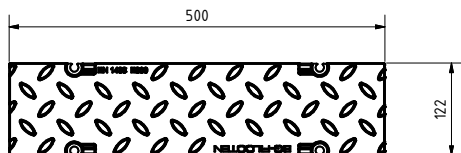

Guss-Abdeckung geschl. / ductile iron cover closed: NW150, E600  
BG code: 17015113; 7,9 kg:

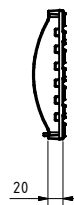

Guss-Abdeckung geschl. / ductile iron cover closed: NW200, E600  
BG code: 17020113; 11,2 kg:

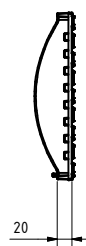

Guss-Abdeckung geschl. / ductile iron cover closed: NW300, E600  
BG code: 17030109; 25,4 kg:

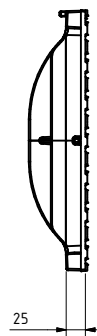
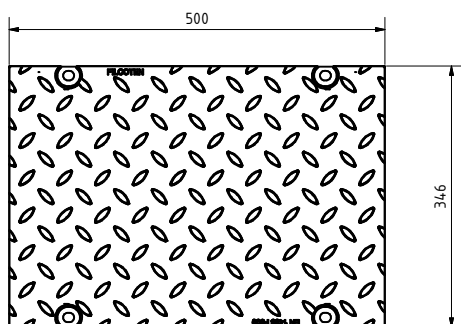

Zubehör / accessories NW100:

connect Kabelauflage / connect cable support: MW31/31  
BG code 19010410:

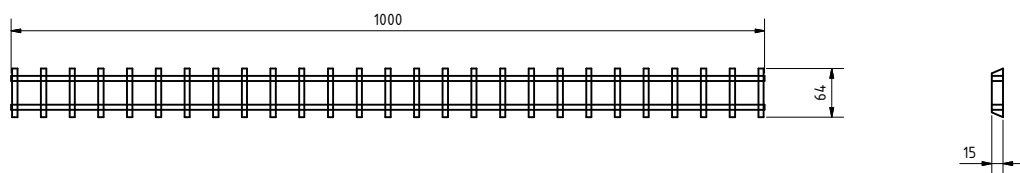

Stirnplatte / Front cap:  
BG code: V 19010230; 0,3 kg:

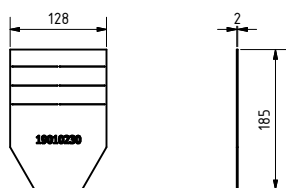

Stirnplatte / Front cap:  
BG code: PA 19010401; 0,1kg:

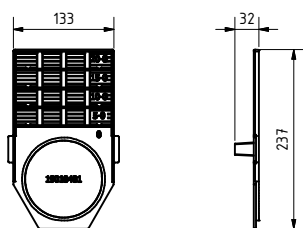

Verschraubungsmaterial / Bolting material:  
BG code: V 32103; BG code: E 32109:



Zubehör / accessories NW150:

connect Kabelauflage / connect cable support: MW31/31  
BG code 19015410:

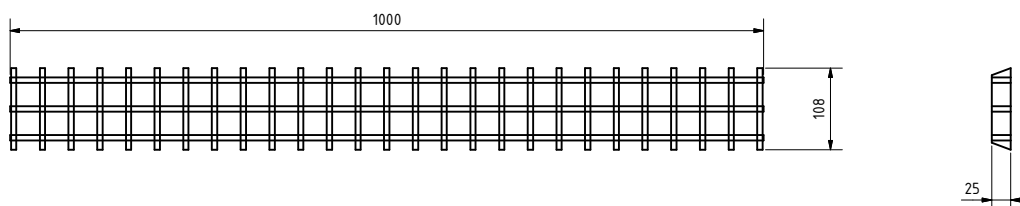

Stirnplatte / Front cap:  
BG code: V 19015230; 0,5 kg:

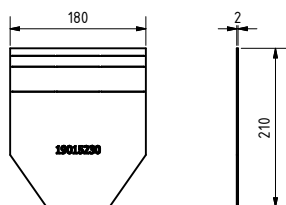

Verschraubungsmaterial / Bolting material:  
BG code: V 32103; BG code: E 32109:



Zubehör / accessories NW200:

connect Kabelauflage / connect cable support: MW31/31  
BG code 19020410:

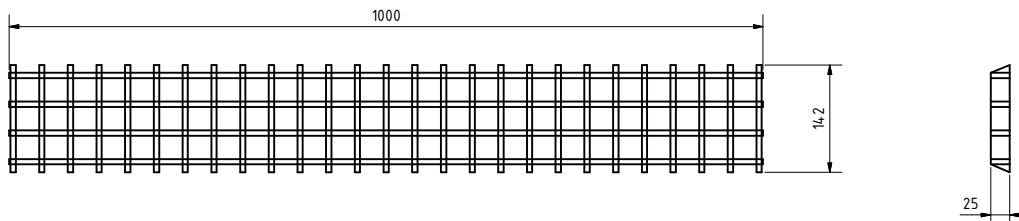

Stirnplatte / Front cap:  
BG code: V 19020230; 0,8 kg:

Verschraubungsmaterial / Bolting material:  
BG code: V 32103:      BG code: E 32109:

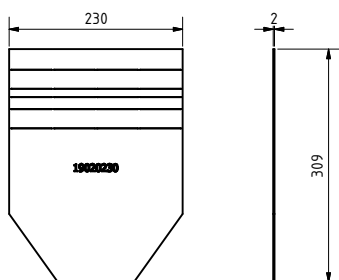

Zubehör / accessories NW300:

connect Kabelauflage / connect cable support: MW31/31  
BG code 19030410:

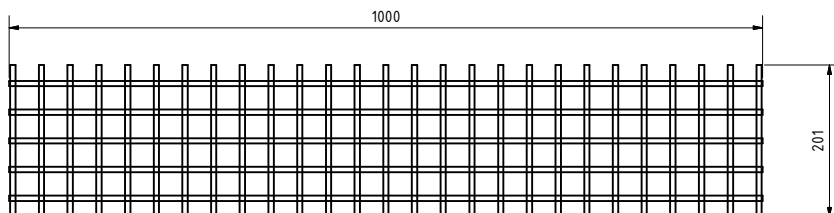

Stirnplatte / Front cap:  
BG code: V 19030213; 1,7 kg:

Verschraubungsmaterial / Bolting material:  
BG code: V 32110:

