

A-A (1 : 7)

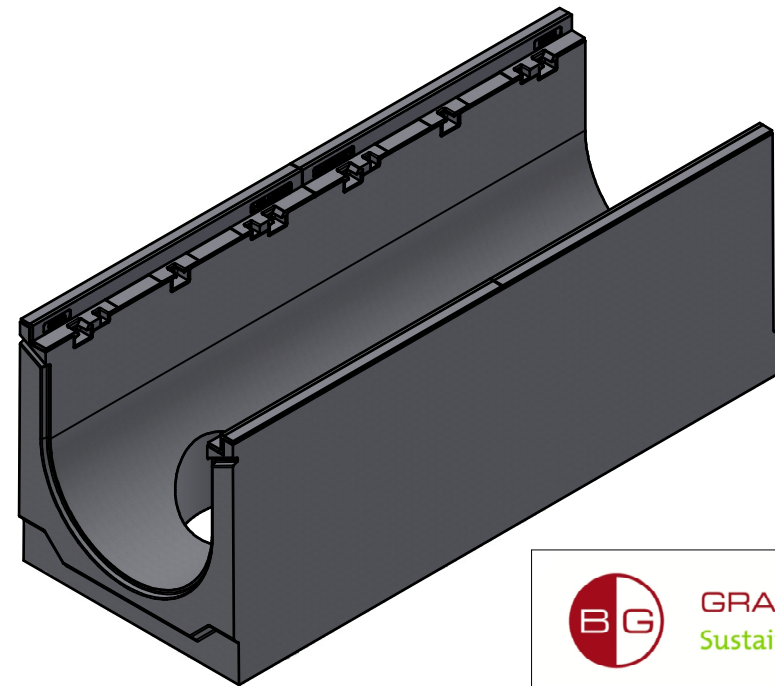

Toleranzen lt. EN1433 / tolerances acc. to EN1433

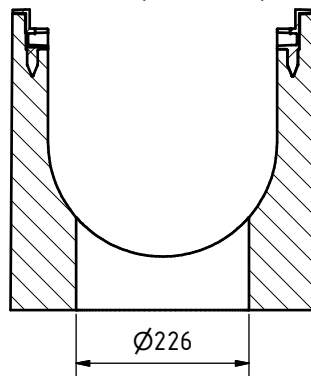

GRASPOINTNER
Sustainable innovation.

A-4882 Gessenschwandt 39 Tel.: +43-6233-8900-0
E-mail: office@bg-graspointner.com Fax: DW 303

BG-CLASSIC
BGZ-S SV G mit Ablauf
BGZ-S SV G with outlet
NW300 No.0 DN200

BG-Code.: 16801

Revision: 01

Name.: SPSA

Date.: 23.08.2021