

A-A (1 : 5)

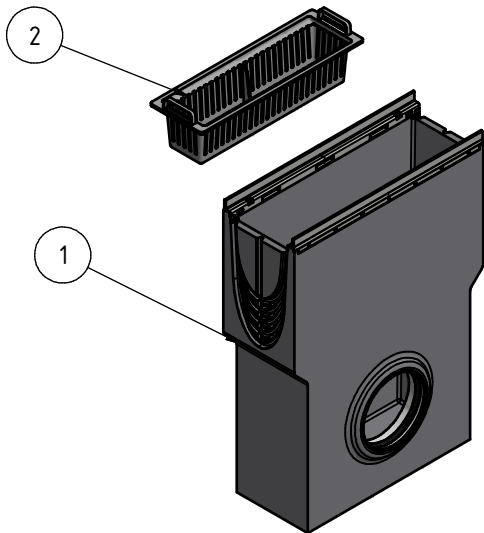

Bauteilliste / component list			
Nr. / No.	Anzahl / amount	Art. Nr. / Art. No.	Beschreibung / description
1	1	10615390	pro Sinkkasten Edelst. inkl. KG-Muffe pro sump unit stainl. with pipe coupling NW150 500/202/690 DN150 Dm160
2	1	22516	Schlammeimer/slit bucket NW150



GRASPOINTNER
Sustainable innovation.

A-4882 Gessenschwandt 39 Tel.: +43-6233-8900-0
E-mail: office@bg-graspointner.com Fax: DW 303

BG-FILCOTEN
pro Sinkkasten Edelstahl-Zarge SET
pro sump unit stainl. steel edge KIT
NW150 DN150 Dm160

BG-Code.: 10615392	Revision: 01
Name.: SPSA	Date.: 12.08.2021