

Innensechskant Gr. 5
hexagon socket wrench size 5

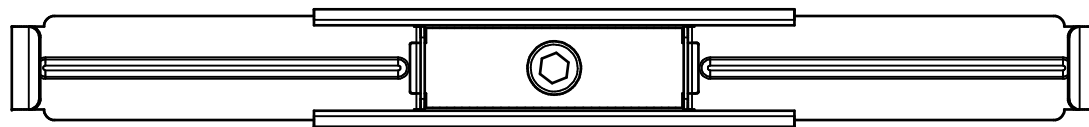
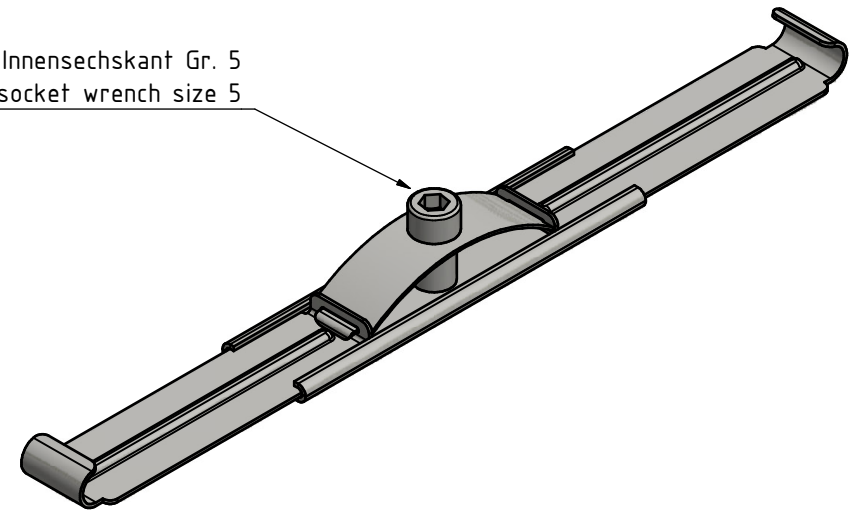

GRASPOINTNER
Sustainable innovation.

A-4882 Gessenschwandt 39 Tel.: +43-6233-8900-0
E-mail: office@bg-graspointner.com Fax: DW 303

BG-FILCOTEN
Vandalismussicherung
anti-vandalism locking device
NW200

BG-Code.: 32089

Revision: 01

Name.: SPSA

Date.: 13.08.2021