

A-A

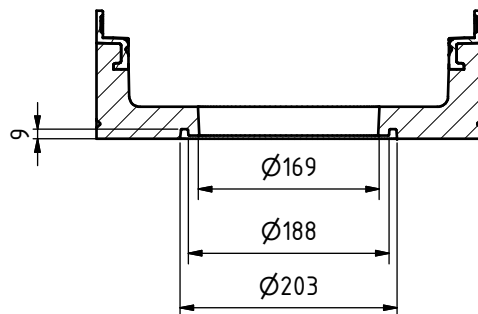

Toleranzen lt. EN1433 / tolerances acc. to EN1433



GRASPOINTNER
Sustainable innovation.

A-4882 Gessenschwandt 39 Tel.: +43-6233-8900-0
E-mail: office@bg-graspointner.com Fax: DW 303

BG-FILCOTEN
pro G mini mit Ablauf
pro G mini with outlet
NW 300 BH120 DN 200

BG-Code.: 10530170

Revision: 01

Name.: SPSA

Date.: 11.05.2021