

Rinne / Channel:

FILCOTEN pro NW400 30-0 G

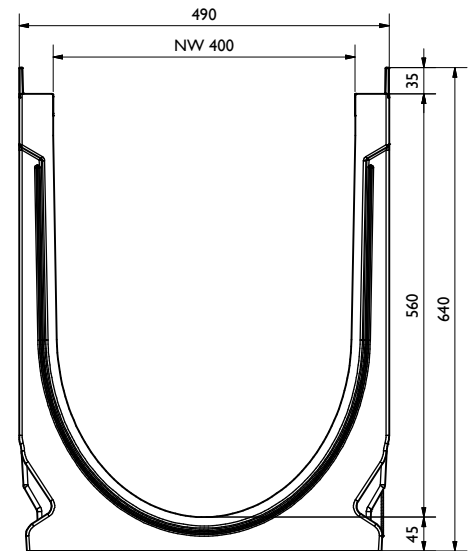
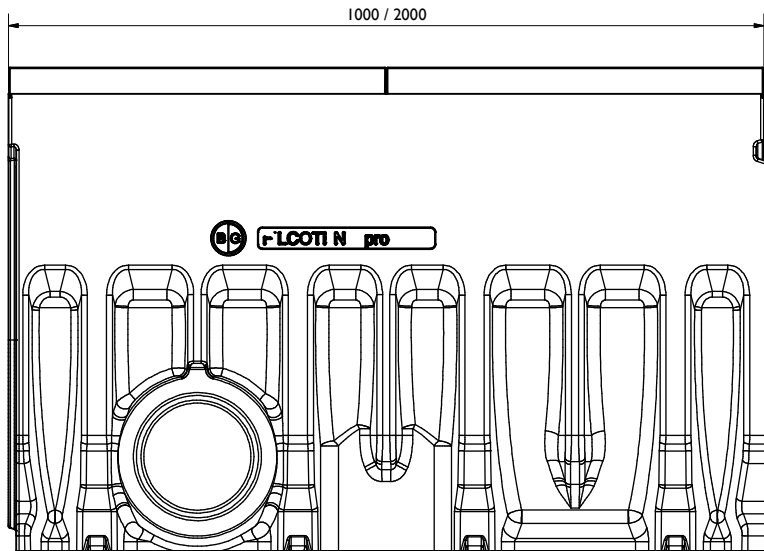

**Filtereinheiten / filter units:**

19540910 Vorfiltermatte Länge 5000mm, Breite 500mm  
prefiltermat lenght 5000mm, width 500mm

195009...: Filtermaterial / filter-material Big Bag

19040360 Trapez-Lochblech aus Edelstahl Länge 2000mm/1000mm

19040361 trapezoidal perforated sheet metal lenght 2000mm/1000mm  
made out of stainless steel

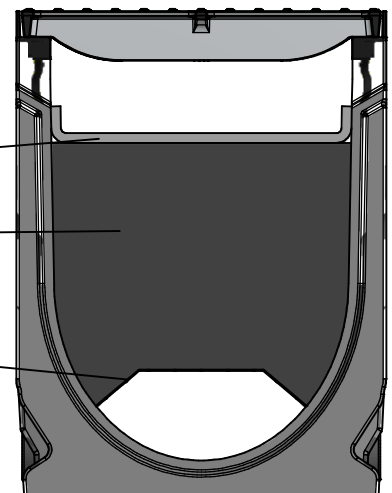

Rinne / channel - Maße / dimensions [mm]					
Typ	Höhe A height A	Höhe B height B	Länge length	BG code G	Gewicht weight G [kg]
30-0	640	640	2000	106401166	287
30-0	640	640	1000	106411166	145

Legende / explanation:	
FCT:	FILCOTEN
E:	Edelstahl / stainless steel
V:	verzinkter Stahl / galvanized steel
G:	Gußeisen / ductile iron
H:	Holz / wood

Gußrost / Ductile iron  
grating:

BG code: GJS 17040181; 34,5kg; E600kN SW18/220

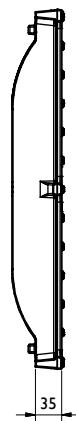
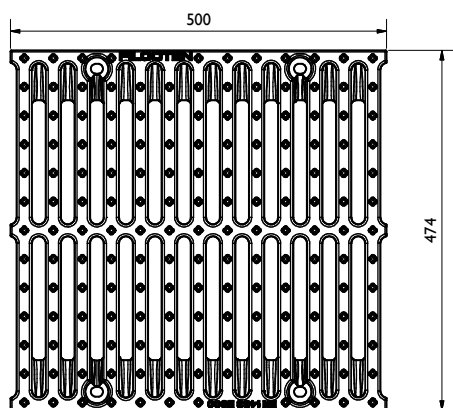

Stirn-/ Endplatte / front- /  
end-cap:

BG code: E 19040350; 4,5kg

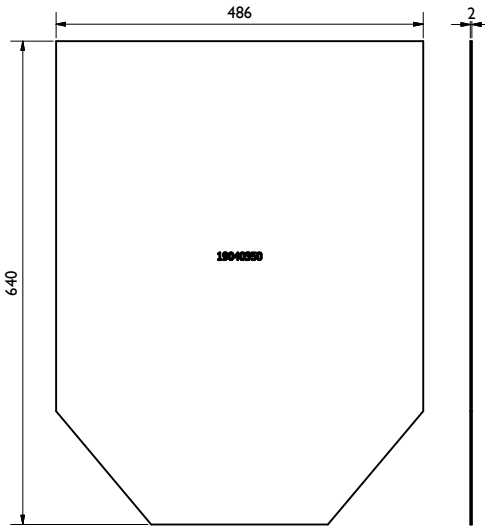

BG code: E 19040351; 5,5kg

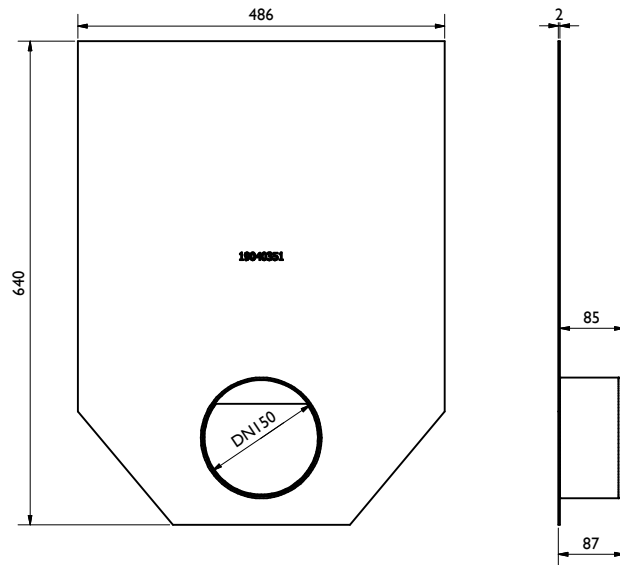

Schottblech / partition  
sheet:

BG code: E 19040353; 2kg

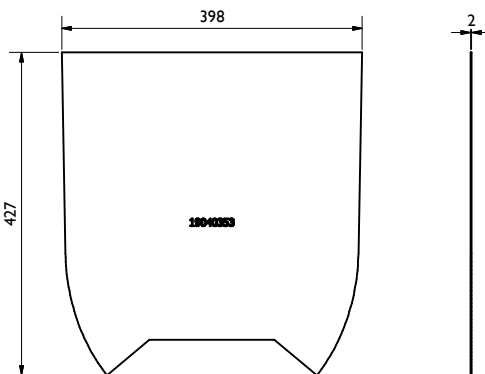

Verschraubungsmaterial / Bolting  
material:

BG code: V 32110, E 32122  
(Gussrost / Ductile iron grating)



Werkzeug zum Filtermaterial Glätten / tool for substrat  
flattening :

BG code: H 19040500, 1kg

