

Rinne / Channel:

FILCOTEN tec NW200 V-E: C250
 BG code V: 10220200 (10220250); 30,2 kg (15,1 kg):
 BG code E: 10220300 (10220350); 30,2 kg (15,1 kg):

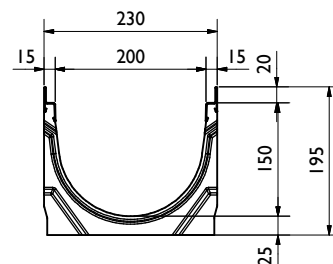

FILCOTEN tec NW200 V-E: C250
 BG code V: 10420200 (10420250); 34 kg (17 kg):
 BG code E: 10420300 (10420350); 34 kg (17 kg):

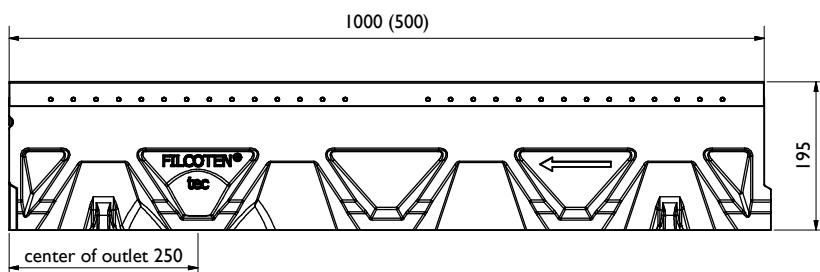
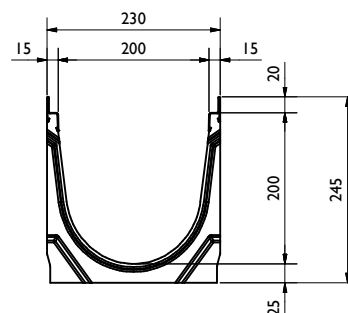
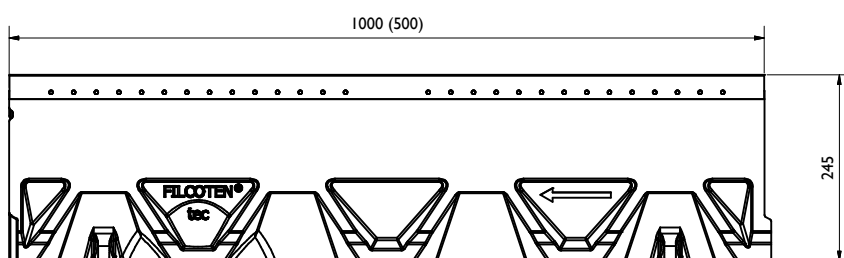

Legende / explanation:	
FCT:	FILCOTEN HPC
V:	verzinkter Stahl / galvanized steel
E:	Edelstahl / stainless steel
G:	Gußeisen / ductile iron
H:	Holz / wood

Roste, Abdeckungen / grates, covers:

Lochrast / Perforated grating: Dm 6; C250
BG code: V 17020228 (17020229), E 17020328 (17020329); 13,5kg (6,7kg):

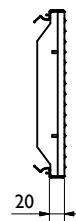
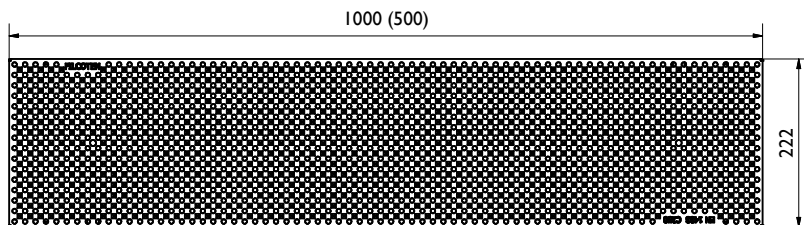

Gitterrost / Mesh grating: MW 30/10; B125
BG code: V 17020220 (17020221), E17020320 (17020321); 6kg (3,1kg):

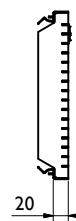
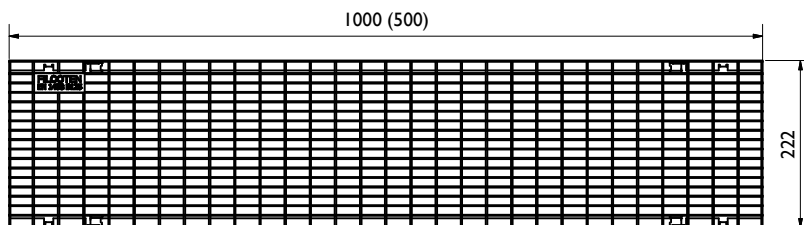

Gitterrost / Mesh grating: MW 30/10; C250
BG code: V 17020222 (17020223), E 17020322 (17020323); 8,8kg (4,5kg):

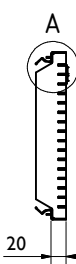
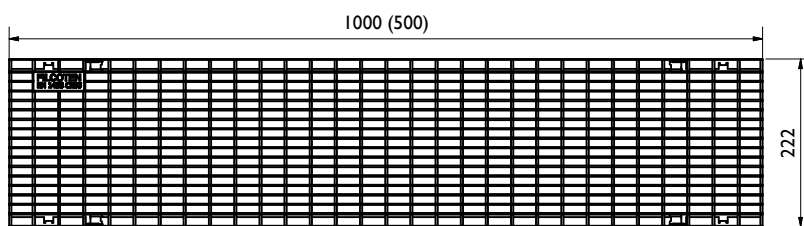

A (1 : 2)



Gußrost / Ductile iron grating: MW 29/13; C250
BG code: GJS 17020101; 7,3kg:

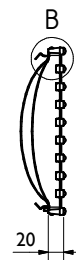
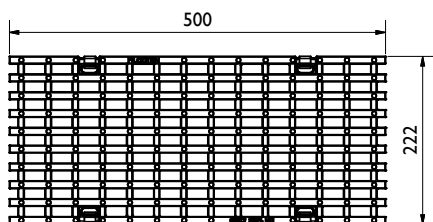

B (1 : 2)



Zubehör / accessories:

Sinkkasten / Sump unit:
inkl. Schlammweimer / incl. silt bucket (22512; 0,7 kg)
BG code: V 10420292; 48,7 kg;
BG code: E 10420392; 48,7 kg;

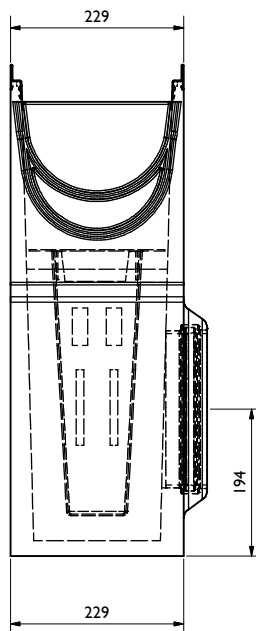
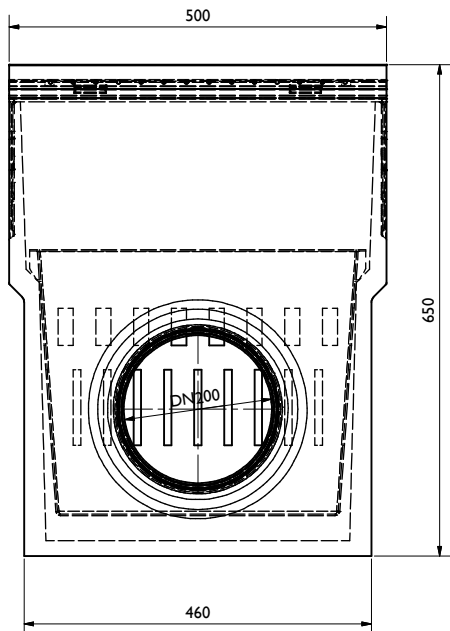

Endplatte / end cap
BG code: V 19020230, E 19020330; 0,8 kg;

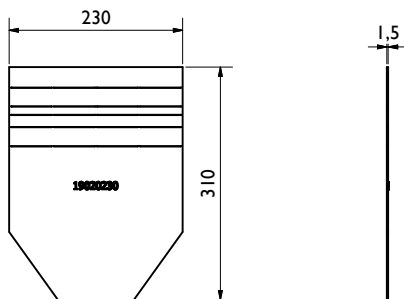

Endplatte mit Ablauf / end cap with outlet
BG code: V 19020231, E 19020331; 1 kg

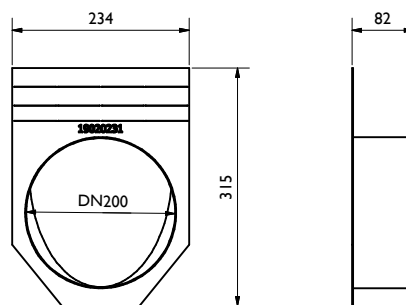

Endplatte mit Ablauf / end cap with outlet
BG code: V 19020232, E 19020332; 0,5 kg

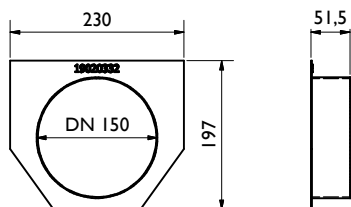

Vandalismus Verriegelung / Anti-vandalism locking device:
BG code: E 32089; 0,1 kg

